



Connector clips

Fixing Elements designed for connection interfaces used in the automotive industry

MADE FOR REAL 

The aim of this brochure

To meet the many demands for classification of Connector Clips based on Connector Interface and not for fixing element, we have created a new subdivision presented below. This allows a benefit in terms of speeding up the application for our customers.

Therefore, different types of Connector Clips have been identified based on the shape of the Connector Interface, further subdivided on the basis of their size.

How to read the brochure

We have identified 37 different types of Connector Interfaces according to their geometry and dimension.

Following a legend for helping you in this division:

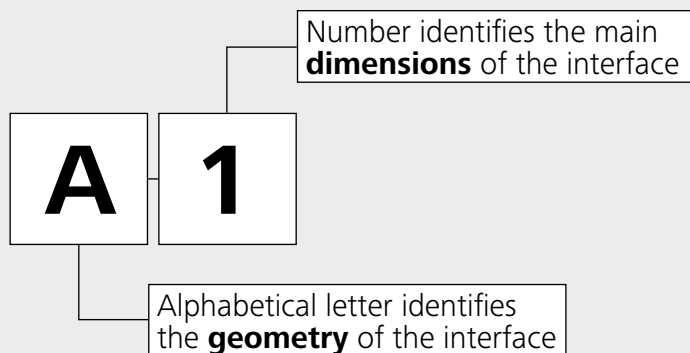

Example:
Connector Interface – Type A1

The technical drawing illustrates the Connector Interface Type A1. It includes an isometric view on the left and two orthographic views on the right. The side view shows dimensions: 1.7 ±0.2, 7 ±0.4, and 1 ±0.2. The front view shows dimensions: 6 ±0.3, 12 (+0.6/-0.2), 10.4 ±0.5, and (22).

Connector Interfaces at a glance

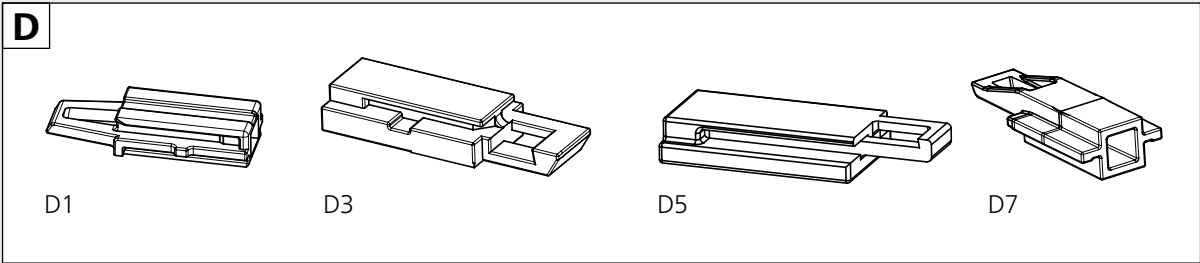
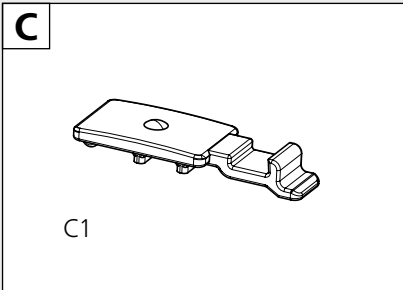
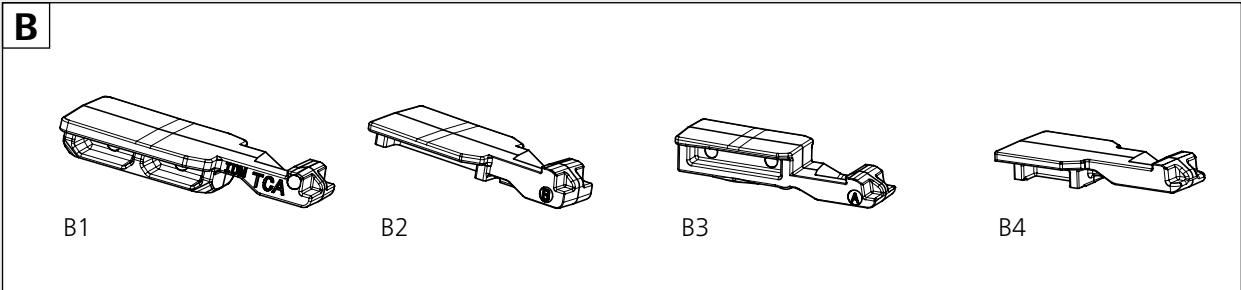
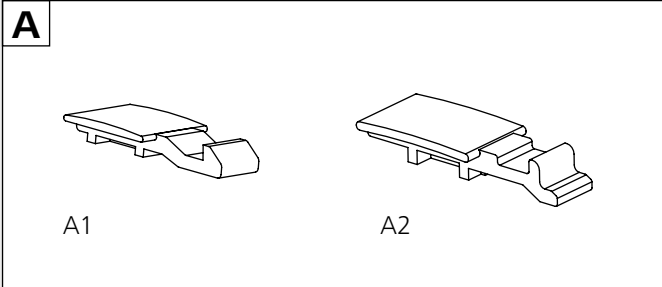

Connector Interfaces at a glance – continued

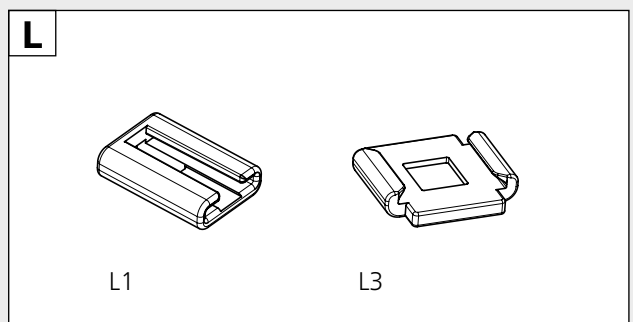
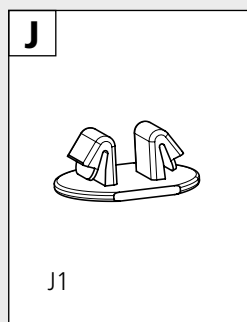
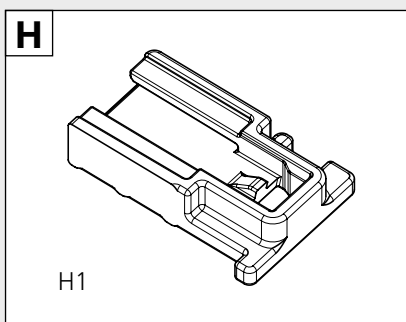
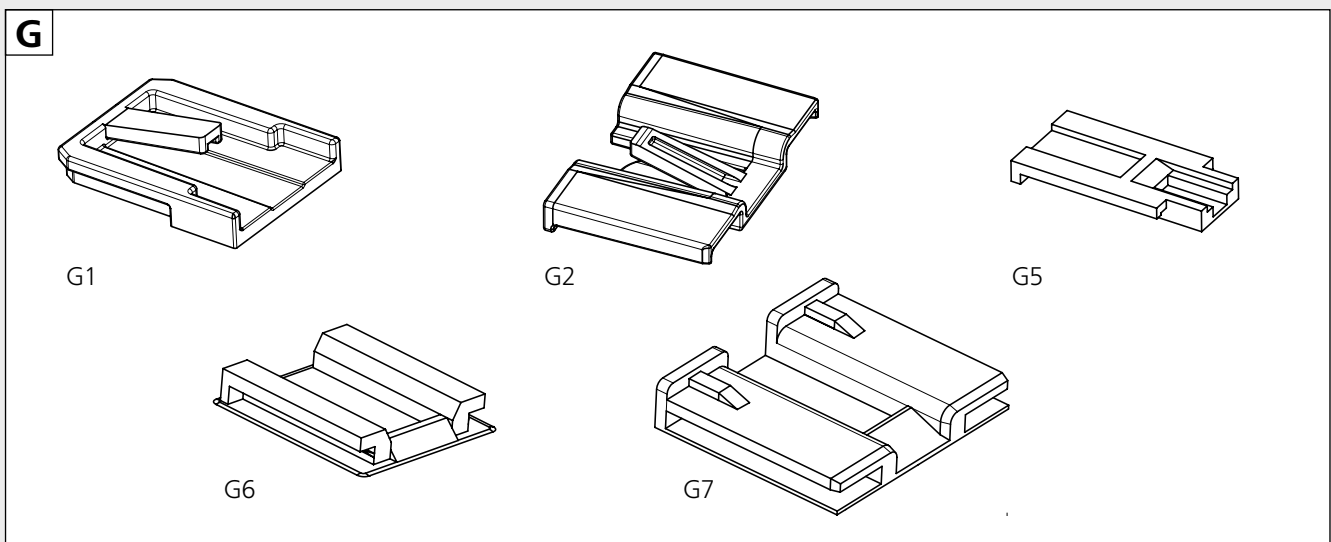
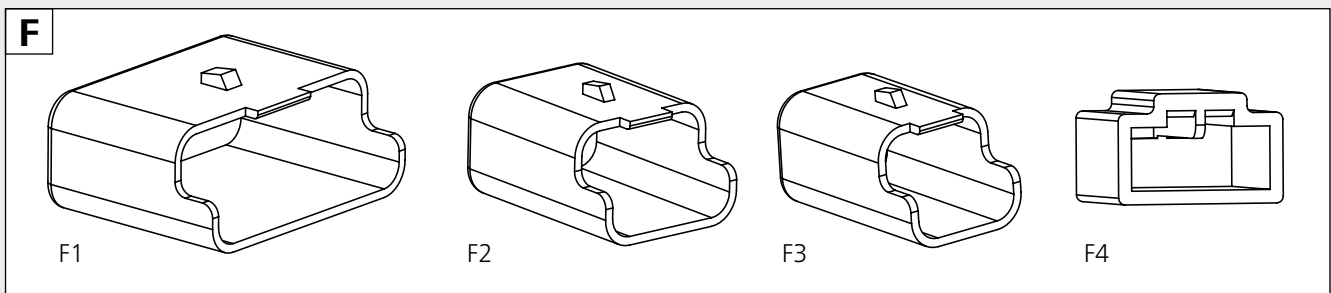
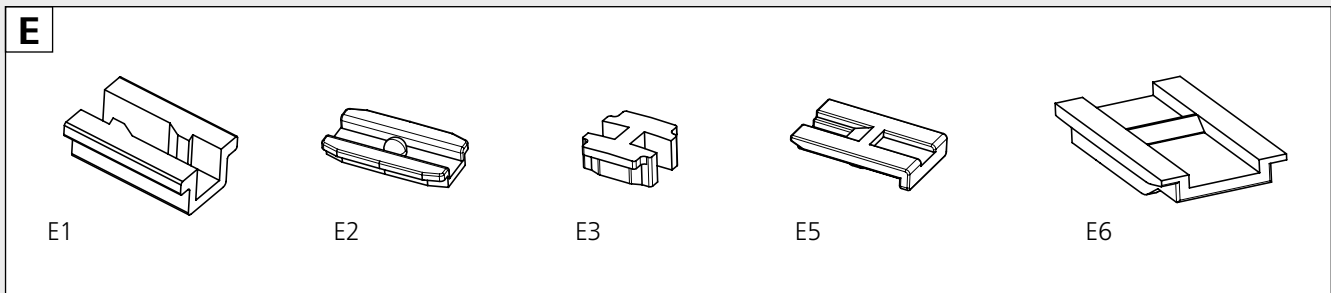

Connector Interfaces at a glance – continued

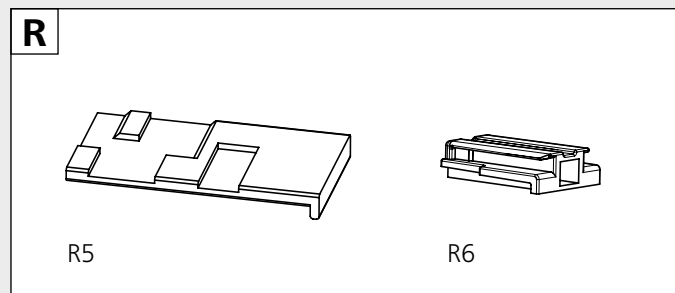
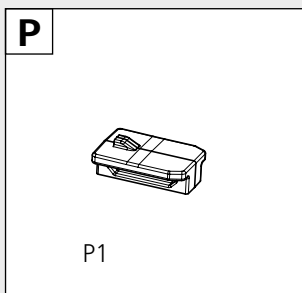
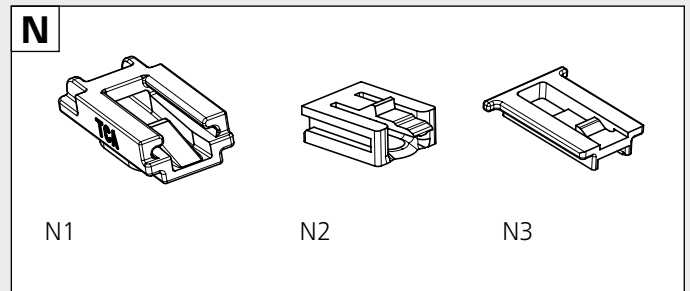
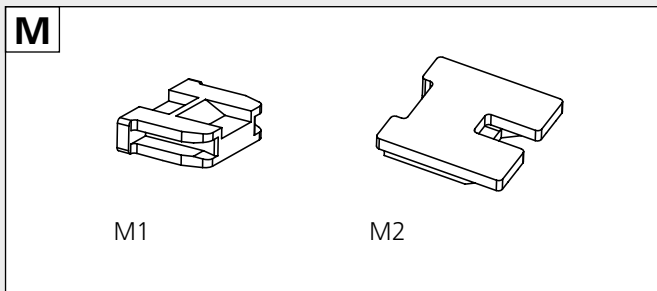

Content

A1	Page 6	D7	Page 20	G1	Page 28	M2	Page 33
A2	Page 8	E1	Page 21	G2	Page 29	N1	Page 34
B1	Page 10	E2	Page 23	G5	Page 29	N2	Page 34
B2	Page 11	E3	Page 24	G6	Page 30	N3	Page 35
B3	Page 15	E5	Page 25	G7	Page 30	P1	Page 35
B4	Page 16	E6	Page 25	H1	Page 31	R5	Page 36
C1	Page 17	F1	Page 26	J1	Page 31	R6	Page 36
D1	Page 18	F2	Page 26	L1	Page 32		
D3	Page 20	F3	Page 27	L3	Page 32		
D5	Page 20	F4	Page 27	M1	Page 33		

Connector Clips

Connector Interface –
Type A1

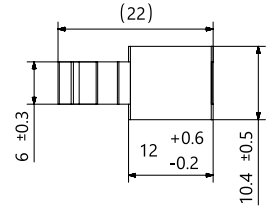
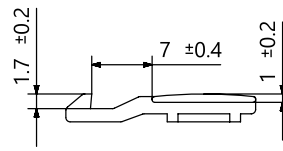
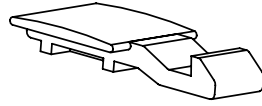

PART DESCRIPTION	Drawing	for Hole Ø (FH)	Panel Thickness	Height (H)	Length (L)	Width (W)	Article-No.
Connector Cap							
CCA11ALD90°-PA6GF30-BK		-	-	10.3	22.8	17.3	151-03172
Connector Clip, edge							
CCEC3.0TP-PA66HIRHS-BK		-	1.0 - 3.0	11.9	23.5	10.4	151-00611
CCEC3.0SV-PA66HIRHS-BK		-	1.0 - 3.0	15.0	23.5	13.4	151-01058
CONNECTOR-CLIP EC6-PA66HIRHS-BK		-	1.0 - 3.0	15.0	24.0	10.4	150-92600
EC6mod-PA66HIRHS-BK		-	1.0 - 3.0	15.5	22.0	10.4	151-00464
CCEC3.0TP-PA66HIRHS-BK		-	1.0 - 3.0	18.1	23.5	10.4	151-02270
EC11-PA66HIRHS-BK		-	1.5 - 3.0	10.4	24.0	12.5	155-40602
EC42-PA66HIRHS-BK		-	1.5 - 4.0	18.0	24.0	13.4	151-00429
EC43-PA66HIRHS-BK		-	1.5 - 4.0	18.0	24.0	13.4	151-00430

All dimensions in mm. Subject to technical changes.

Connector Clips

Connector Interface –
Type A1

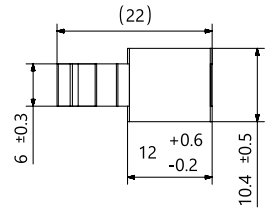
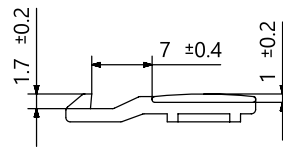
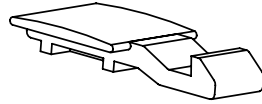

PART DESCRIPTION	Drawing	for Hole Ø (FH)	Panel Thickness	Height (H)	Length (L)	Width (W)	Article-No.
ECC1CPT-PA66HIRHS-BK		-	3.0 - 6.0	18.0	23.9	16.9	151-00499
CC10EC1.5SV-PA6-BK		6.5	1.0 - 1.4	10.9	32.4	19.0	151-03285
Connector Clip, oval hole, arrow head							
Steckerhalter-Oval-PA46-GY		6.2 - 12.2	0.5 - 3.0	15.8	29.5	22.0	151-01854
ECC1CPT-PA66HIRHS-BK		6.2 - 12.2	0.5 - 3.0	15.8	29.5	22.0	133-00004
Connector Clip Oval II-PA66HIRHS-BK		6.2 x 12.2	2.5 - 4.5	18.2	22.0	27.5	133-00533
Connector Clip, oval hole, fir tree							
YCCFT82x185-PA66HIRHS		8.2 x 18.5	1.5 - 4.5	16.0	28.4	17.4	151-01842
Connector Clip, round hole, arrow head, sealed							
YCCSFT6.5PT0.8-1.5MD-PA66HIRHS-BK		6.3 - 6.7	0.8 - 1.5	16.5	28.5	22.0	151-00934

All dimensions in mm. Subject to technical changes.

Connector Clips

Connector Interface –
Type A2

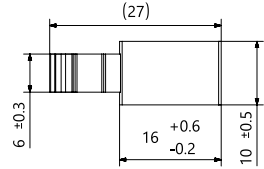
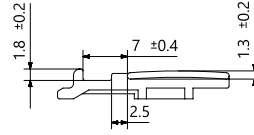
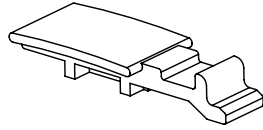

PART DESCRIPTION	Drawing	for Hole Ø (FH)	Panel Thickness	Bundling Bar Length	Bundle Ø max.	Height (H)	Length (L)	Width (W)	Article- No.
Bundling Clip, connector									
YAZ-CONN-TAPE-CLIP-PA66HS-BK		-	-	55.0	-	6.5	55.0	10.0	155-31102
Connector Clip-PA66HIRHS-BK		-	-	55.0	-	8.8	55.0	9.0	151-03085
Connector Clip, cable tie, 2 pieces									
T50RYCCA-PA66HS/PA66HIRHS-BK		-	-	-	50.0	7.5	200.0	4.6	156-00507
T50RYCCB-PA66HS/PA66HIRHS-BK		-	-	-	50.0	7.5	200.0	4.6	156-00521
Connector Clip, oval hole, arrow head									
YCCSFT62122-PA66HIRHS-BK		6.2 x 12.2	0.6 - 1.0	-	-	14.1	27.5	16.0	151-00513
YCCSFT6.5x13PT2.5-3.5-PA66HIRHS-BK		6.5 x 13.0	-	-	-	16.1	29.5	19.0	151-01356
Connector Clip, oval hole, arrow head, sealed									
YCCSFT6.5X13PT0.6-2.0-MD-PA66HIRHS/EPDM-BK		6.5 x 13.0	0.6 - 2.0	-	-	16.0	29.5	19.0	151-01273
Connector Clip, oval hole, fir tree									
YCCFT62x122-PA66HIRHS		6.2 x 12.2	0.6 - 6.0	-	-	18.0	21.1	16.0	151-00180

All dimensions in mm. Subject to technical changes.

Connector Clips

Connector Interface –
Type A2

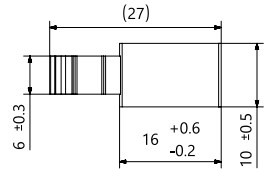
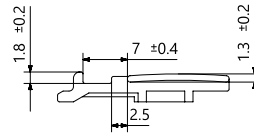
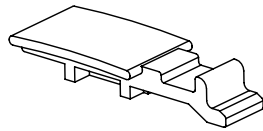

PART DESCRIPTION	Drawing	for Hole Ø (FH)	Panel Thickness	Bundling Bar Length	Bundle Ø max.	Height (H)	Length (L)	Width (W)	Article- No.
Connector Clip, round hole, fir tree									
FT6LG.YAZ.CONNECT-TS-PA66HIRHS-BK		6.4 - 7.1	0.7 - 5.1	-	-	15.3	27.0	16.0	155-30702
CCFT6LG-TS-PA66HIRHS-BK		6.4 - 7.1	0.7 - 5.1	-	-	16.4	34.0	16.0	151-01141
FT6LG.YAZ.CONNECT-TS-PA46-GY		6.4 - 7.1	0.70 - 5.1	-	-	15.3	27.0	16.0	151-01853
FT6LG CC-PA66HIRHS-BK		6.4 - 7.1	0.75 - 6.0	-	-	17.7	27.0	16.0	151-01838
FT6S-Y-CONN-TS-PA66HIRHS-BK		6.5 - 7.0	0.75 - 1.5	-	-	11.1	27.0	16.0	155-43702
YCCFT6S-2-PA66HIRHS-BK		6.5 - 7.0	0.75 - 1.5	-	-	11.1	27.0	16.0	151-01841
YCC-FT6-S-PA66HIRHS-BK		6.5 - 7.0	0.75 - 1.5	-	-	12.1	27.0	16.0	155-38102
FT6LG.M.St.Aufn.II-PA66HIRHS-BK		6.5 - 7.0	0.75 - 5.0	-	-	17.3	27.0	16.0	155-32602
CCFT8LGTS-PA66HIRHS-BK		7.6 - 8.4, M10	0.6 - 6.0	-	-	17.8	27.0	15.0	151-03371

All dimensions in mm. Subject to technical changes.

Connector Clips

Connector Interface –
Type B1

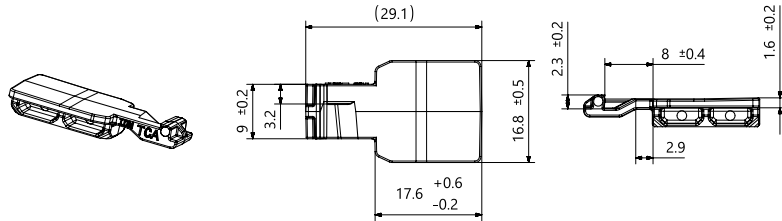

PART DESCRIPTION	Drawing	for Hole Ø (FH)	Panel Thickness	Height (H)	Length (L)	Width (W)	Article-No.
Connector Clip, oval hole, fir tree							
CC17FTOVAL-PA66HIRHSUV-BK		6.2 x 12.2, 6.5 x 12.5, 6.5 x 13.0, 7.0 x 12.0	0.6 - 6.75	21.1	32.7	18.2	151-02806
CC17FTOVALA-PA46-BN		6.2 x 12.2, 6.5 x 12.5, 6.5 x 13.0, 7.0 x 12.0	0.6 - 6.75	21.1	32.7	18.2	151-03030
CC17FT8X15-PA66HIRHSUV-BK		8.0 x 15.0	0.6 - 6.75	19.57	32.7	18.2	151-02961
CC17FT9X17-PA66HIRHSUV-BK		9.0 x 17.0	0.6 - 6.75	20.05	32.7	18.2	151-02807
CC17FT12X17-PA66HIRHSUV-BK		12.0 x 17.0	0.6 - 6.75	21.1	33.1	20.3	151-02936

All dimensions in mm. Subject to technical changes.

Connector Clips

Connector Interface –
Type B2

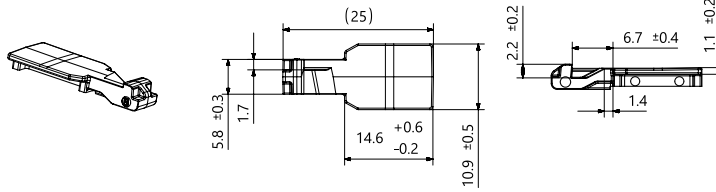

PART DESCRIPTION	Drawing	for Hole Ø (FH)	Panel Thickness	Bundling Bar Length	Stud Ø	Height (H)	Length (L)	Width (W)	Article-No.
Connector Clip									
TRIPLE11CCBRKT-POM-NA		-	-	-	-	10.2	73.0	35.8	151-02661
Connector Clip, edge									
EC46-PA66HIRHSUV-BK		-	1.0 - 3.0	-	-	14.15	35.5	11.18	151-01113
EC52-PA66HIRHSUV-BK		-	1.0 - 3.0	-	-	16.5	34.1	15.0	151-01290
CC11VEC6-PA66HIRHS-BK		-	3.0 - 6.0	-	-	17.3	25.7	14.9	151-02568
EC55CC11-PA66HIRHSUV-BK		-	3.0 - 6.0	-	-	19.02	25.0	14.8	151-03112
Connector Clip, oval hole, arrow head									
CC11AH12X17-PA66HIRHS-BK		12.0 x 17.0	6.25 - 4.75	-	-	30.94	34.5	28.13	151-03126
Connector Clip, oval hole, arrow head, sealed									
SAHOVALCC-PA66HIRHSUV/TPE-BK		6.2 x 12.2, 6.5 x 12.5, 6.5 x 13.0	0.6 - 1.1	-	-	14.48	27.3	22.78	151-02079
CCSFT6.5X12.5-MD-PA66HIRHS-BK		6.5 x 12.5	0.6 - 1.5	-	-	16.0	32.0	16.0	151-01312
CCIVSFT65130-MD-PA66HIR-BK		6.5 x 13.0	0.6 - 2.0	-	-	15.6	29.0	10.0	151-01676
Connector Clip, oval hole, fir tree									
BCC51FTOVAL-PA66HIRHS-BK		6.2 - 12.2, 6.5 x 12.5	0.6 - 6.0	-	-	20.0	51.0	17.6	151-02529

All dimensions in mm. Subject to technical changes.

Connector Clips

Connector Interface –
Type B2

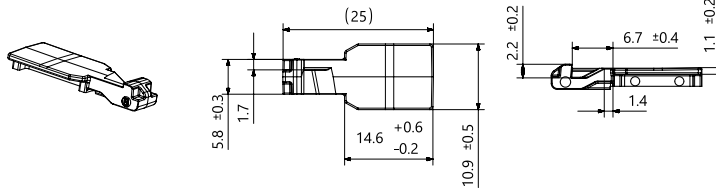

PART DESCRIPTION	Drawing	for Hole Ø (FH)	Panel Thickness	Bundling Bar Length	Stud Ø	Height (H)	Length (L)	Width (W)	Article-No.
CCOVAL6-PA46-BN		6.2 - 12.2, 6.5 x 12.5, 6.5 x 13.0, 7.0 x 12.0	0.6 - 3.0	-	-	15.2	29.3	17.6	151-02516
CCOVALM-PA66HIRHS-BK		6.2 - 12.2, 6.5 x 12.5, 6.5 x 13.0, 7.0 x 12.0	0.6 - 6.0	-	-	20.7	24.9	17.6	151-02288
CC22-PA66HIRHSUV-BK		6.2 x 12.2, 6.5 x 12.5, 6.5 x 13.0, 7.0 x 12.0	0.51 - 6.75	-	-	26.0	25.7	17.53	151-02051
CCOVAL-S-PA66HIRHS-BK		6.2 x 12.2, 6.5 x 12.5, 6.5 x 13.0, 7.0 x 12.0	0.6 - 2.8	-	-	15.9	29.3	17.6	151-02122
CCOVAL6-PA66HIRHSUV-BK		6.2 x 12.2, 6.5 x 12.5, 6.5 x 13.0, 7.0 x 12.0	0.6 - 3.0	-	-	15.2	29.3	17.6	151-01033
CCOVAL-PA66HIRHSUV-BK		6.2 x 12.2, 6.5 x 12.5, 6.5 x 13.0, 7.0 x 12.0	0.6 - 6.0	-	-	19.98	29.3	17.63	151-00925
CCOVAL-PA66HIRHS-NA		6.2 x 12.2, 6.5 x 12.5, 6.5 x 13.0, 7.0 x 12.0	0.6 - 6.0	-	-	19.98	29.3	17.63	151-01259
CCOVAL-PPS-SR		6.2 x 12.2, 6.5 x 12.5, 6.5 x 13.0, 7.0 x 12.0	0.6 - 6.75	-	-	19.98	29.3	17.63	151-01538
CCOVAL12.5SO-PA66HIRHSUV-BK		6.2 x 12.2, 6.5 x 12.5, 6.5 x 13.0, 7.0 x 12.0	0.6 - 6.75	-	-	26.0	24.9	17.6	151-03152
CC16-PA66HIRHSUV-BK		8.0 x 14.0, 8.0 x 15.0	0.60 - 7.75	-	-	23.4	30.0	18.2	151-01297
CC03-PA66HIRHSUV-BK		8.0 x 15.0	0.76 - 6.35	-	-	16.65	24.9	-	151-00496

All dimensions in mm. Subject to technical changes.

Connector Clips

Connector Interface –
Type B2

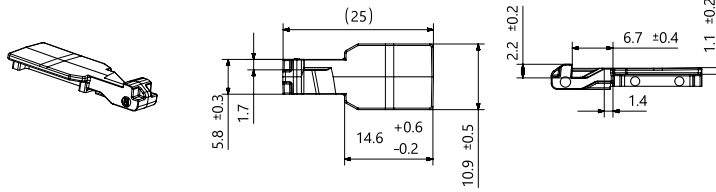

PART DESCRIPTION	Drawing	for Hole Ø (FH)	Panel Thickness	Bundling Bar Length	Stud Ø	Height (H)	Length (L)	Width (W)	Article-No.
CC04-PA66HIRHSUV-BK		8.0 x 15.0	0.76 - 6.35	-	-	25.63	23.8	22.1	151-00597
CC16R-PA66HIRHSUV-BK		8.0 x 15.0, 8.0 x 14.0	0.6 - 3.0	-	-	23.4	30.0	18.2	151-02206
CC09-PA66HIRHSUV-BK		9.0 x 17.0	0.5 - 6.4	-	-	19.4	33.1	21.59	151-00765
CC10-PA66HIRHSUV-BK		9.0 x 17.0	0.5 - 15.5	-	-	28.9	33.1	21.59	151-00807
CC18-PA66HIRHSUV-BK		9.0 x 17.0	0.51 - 9.5	-	-	23.57	30.3	20.32	151-01296
CC11B-PPS-SR		9.0 x 17.0	0.6 - 6.0	-	-	20.60	30.0	18.20	151-02896
CC11-PA66HIRHSUV-BK		9.0 x 17.0, 9.0 x 16.0	0.6 - 6.5	-	-	20.6	30.0	18.2	151-01144
CC15-PA66HIRHSUV-BK		12.0 x 17.0	0.6 - 9.0	-	-	23.6	30.3	20.3	151-01199
Connector Clip, round hole, arrow head									
TRANSMNT90DEG11CC-PA46-BN		12.35	13.5 - 15.0	-	-	35.4	68.2	26.6	151-03197

All dimensions in mm. Subject to technical changes.

Connector Clips

Connector Interface –
Type B2

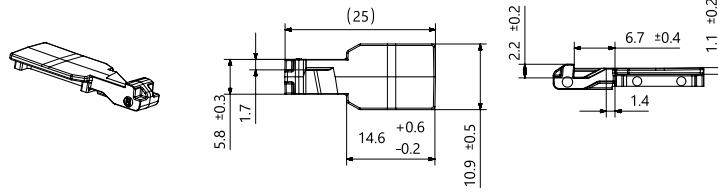

PART DESCRIPTION	Drawing	for Hole Ø (FH)	Panel Thickness	Bundling Bar Length	Stud Ø	Height (H)	Length (L)	Width (W)	Article-No.
Connector Clip, round hole, arrow head, sealed									
SRAH6.5CC-PA66HIRHSUV/TPE-BK		6.35 (hexagonal), 6.5	0.6 - 1.1	-	-	14.48	22.3	22.3	151-02078
SRAH6.5D1.4TCC-PA66HIRHS/TPE-BK/GY		6.35 (hexagonal), 6.5	1.2 - 1.8	-	-	15.08	22.3	22.3	151-02080
Connector Clip, round hole, fir tree									
CC11FT6TS-PA66HIRHS-BK		6.1 - 6.7	0.6 - 5.5	-	-	18.9	25.7	16.5	151-02873
CC7FT6OS25-PA66HIRHS-BK		6.1 - 6.9	0.6 - 6.0	-	-	22.0	34.6	12.5	151-02885
YCCFT6LGTS2-PA66HIRHS-BK		6.1 - 6.9	0.7 - 5.0	-	-	16.75	31.3	16.0	151-00965
CC19-PA66HIRHSUV-BK		6.1 - 6.9, 6.35 (hexagonal)	0.6 - 5.5	-	-	19.7	24.9	17.0	151-01342
CCFT6LGTS12.5-PA66HIRHS-BK		6.5 - 7.0	0.7 - 6.0	-	-	20.9	37.8	16.0	151-03104
CC11FTM6-PA46-BN		M6	1.3 - 4.5	-	-	20.7	24.9	15.8	151-02458
CC11FTM6-PA66HIRHSUV-BK		M6	1.3 - 4.5	-	-	20.7	24.9	15.8	151-02459
Connector Clip, stud size 5 mm									
SB5CC-PA66HIRHSUV-BK		-	-	-	M5, T5	17.1	41.8	14.5	151-01044
Double connector retainer									
CC90BRKT-PA66HIRHSUV-BK		-	-	108.4	-	10.9	108.4	53.0	151-01249

All dimensions in mm. Subject to technical changes.

Connector Clips

Connector Interface –
Type B3

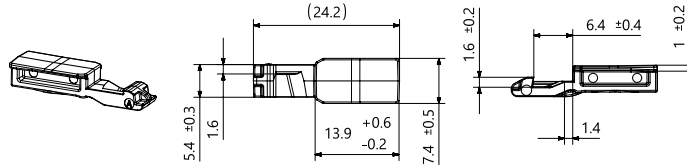

PART DESCRIPTION	Drawing	for Hole Ø (FH)	Panel Thickness	Height (H)	Length (L)	Width (W)	Article-No.
Connector Clip							
CCSTDFAKRAADP-PA66HIRHS-NA		-	-	9.4	34.4	17.5	133-02489
Connector Clip, edge							
EWCAP7EC1-3OTP-PA66HIRHS-BK		-	1.0 - 3.0	15.4	24.2	10.2	151-03173
EC54-PA66HIRHSUV-BK		-	1.0 - 3.0	17.5	24.7	10.1	151-01042
Connector Clip, oval hole, arrow head, sealed							
SAHOVAL1.4TCC7-PA66HIRHS/TPE-BK/GY		6.2 x 12.2, 6.5 x 12.5, 6.5 x 13.0	1.2 - 1.8	17.55	27.3	22.78	151-02996
Connector Clip, oval hole, fir tree							
CCOVAL2-PA66HIRHSUV-BK		6.2 x 12.2, 6.5 x 12.5, 6.5 x 13.0, 7.0 x 12.0	0.6 - 6.0	22.35	29.0	17.6	151-01108
CC20-PA66HIRHSUV-BK		9.0 x 17.0	0.6 - 9.5	26.1	25.5	20.3	151-01397
CC17-PA66HIRHSUV-BK		12.0 x 17.0	0.6 - 9.0	26.2	29.9	20.3	151-01295
Connector Clip, round hole, arrow head							
CC14-PA66HIRHS-NA		5.0 - 5.7	0.65 - 1.4	13.6	25.5	16.66	151-01243
Connector Clip, round hole, fir tree							
CC21-PA66HIRHSUV-BK		9.0 x 17.0	0.6 - 3.5	19.55	19.0	25.15	151-01889

All dimensions in mm. Subject to technical changes.

Connector Clips

Connector Interface –
Type B4

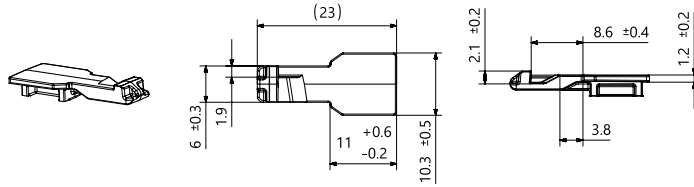

PART DESCRIPTION	Drawing	for Hole Ø (FH)	Panel Thickness	Height (H)	Length (L)	Width (W)	Article-No.
Connector Clip, oval hole, fir tree							
CCDOP62x122-PA66HIRHS-BK		6.2 x 12.2	0.7 - 5	17.65	20.5	10.3	151-02431

All dimensions in mm. Subject to technical changes.

Connector Clips

Connector Interface –
Type C1

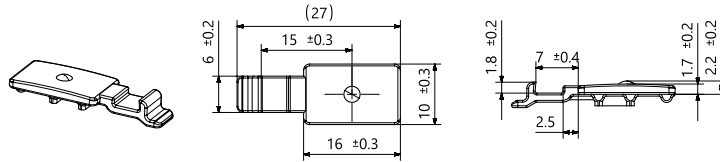

PART DESCRIPTION	Drawing	for Hole Ø (FH)	Panel Thickness	Height (H)	Length (L)	Width (W)	Article-No.
Connector Clip, edge							
CCEC3TR-PA66HIRHS-BK		-	1.0 - 3.0	11.7	27.0	10.0	151-01142
Connector Clip, oval hole, arrow head							
YCCKSFT62x122PT0.7-1.3 90°-PA66HIRHS-BK		6.2 x 12.2	0.7 - 1.3	11.1	27.0	21.0	151-00833
YCCKSFT62x122PT0.7-1.3-PA66HIRHS-BK		6.2 x 12.2	0.7 - 1.3	11.4	27.0	16.0	151-00835
YCCKSFT62x122PT1.7-2.3 90°-PA66HIRHS-BK		6.2 x 12.2	1.7 - 2.3	12.1	27.0	21.0	151-00834
YCCKSFT62x122PT1.7-2.3-PA66HIRHS-BK		6.2 x 12.2	1.7 - 2.3	12.4	27.0	16.0	151-00836
CCKSFT62x122PT3.5-PA66HIRHS-BK		6.2 x 12.2	3.3 - 3.7	13.8	27.5	16.0	151-01102
YCCKSFT75X150-PA66HIR-BK		7.5 x 15.0	0.7 - 1.7	12.7	27.0	16.0	151-01669
Connector Clip, round hole, arrow head							
YCCKSFT6.5-PA66HIRHS-BK		6.3 - 6.7	0.7 - 1.3	10.9	27.0	16.0	151-01869
YCCKSFT6.5-PT1.7-2.3-PA66HIRHS-BK		6.3 - 6.7	1.7 - 2.3	11.9	27.0	16.0	151-01870
Connector Clip, round hole, fir tree							
CCFT5-6D16-PA66HIRHS-BK		M6	0.7 - 4.5	16.3	27.5	16.0	151-01878

All dimensions in mm. Subject to technical changes.

Connector Clips

Connector Interface –
Type D1

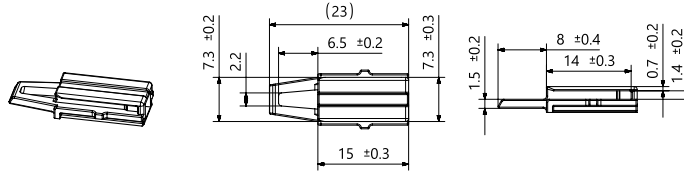

PART DESCRIPTION	Drawing	for Hole Ø (FH)	Panel Thickness	Height (H)	Length (L)	Width (W)	Article-No.
Connector Clip, oval hole, arrow head							
CCIVSFT6513T4-PA66-BK		6.5 x 13.0	0.6 - 4.0	15.6	19.6	23.6	151-01539
CCIVSFT6.5x130-PA46-GY		6.5 x 13.0	0.7 - 3.0	14.6	23.0	19.6	151-02450
CCIVSFT6.5x130-PA66HIRHS-BK		6.5 x 13.0	0.7 - 3.0	14.6	23.0	19.6	133-00392
CCSFT6513PT1.8-2.5-PA66HIRHS-BK		6.5 x 13.0	1.8 - 2.5	18.6	26.5	16.0	151-02528
CC20SFT712-PA66HIRHS		7.0 x 12.0	0.7 - 2.0	14.7	23.0	16.0	151-02898
CCSFT8.0x15.0-PA66-BK		8.0 x 15.0	0.8 - 2.8	13.0	23.0	21.36	151-01807
Connector Clip, oval hole, arrow head, sealed							
CC33SFT6.5X13-MD-PA66HIRHS/CR-BK		6.5 x 13.0	2.0 - 2.0	18.6	28.0	19.0	151-03328
Connector Clip, oval hole, fir tree							
3FAKRACCBOX9X17OFT-PA66HIRHS-BK		9.0 x 17.0	0.6 - 2.25	28.57	26.6	18.23	133-04068
4FAKRACCBOX9X17OFT-PA66HIRHSUV-BK		9.0 x 17.0	0.6 - 2.25	37.8	26.5	18.7	151-02750

All dimensions in mm. Subject to technical changes.

Connector Clips

Connector Interface –
Type D1

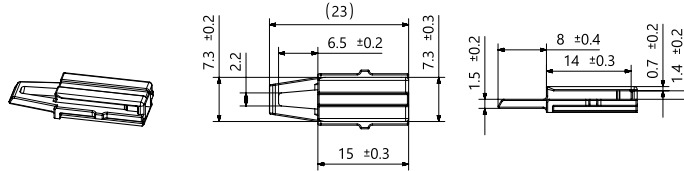

PART DESCRIPTION	Drawing	for Hole Ø (FH)	Panel Thickness	Height (H)	Length (L)	Width (W)	Article-No.
Connector Clip, round hole, arrow head							
CC31SFT7KH3X13-PA66HIRHS-BK		-	0.7 - 2.5	16.6	23.0	19.6	151-03194
CCSFT5-PA66HIRHS-BK		4.8 - 5.2	0.7 - 2.3	11.2	23.0	16.0	151-00980
CCSFT6.3-PA66-BK		6.3 - 6.5	0.7 - 2.5	13.0	23.0	21.4	151-01809
CCSFT6.5-PA66HIRHS-BK		6.3 - 6.7	1.7 - 2.3	12.1	23.0	16.1	151-00775
Connector Clip, round hole, fir tree							
CCFT6LG-PA66HIRHS-BK		6.0 - 6.7	0.7 - 4.0	17.0	23.0	16.1	151-00785
CCFT6XLG-PA66HIRHS-BK		6.0 - 6.7	0.7 - 11.0	24.2	23.0	16.1	151-00786

All dimensions in mm. Subject to technical changes.

Connector Clips

Connector Interface –
Type D3

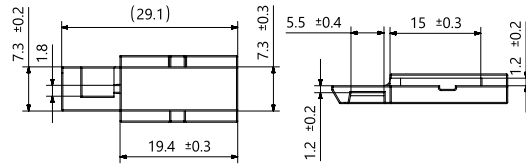
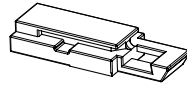

PART DESCRIPTION	Drawing	for Hole Ø (FH)	Panel Thickness	Height (H)	Length (L)	Width (W)	Article-No.
Connector Clip, oval hole, arrow head							
CC4AHOVAL7X12-PA66HIRHSUV-BK		7.0 x 12.0	1.4 - 1.6	16.0	30.1	16.0	151-02563
Connector Clip, round hole, fir tree							
CCFT6TS11-PA46-GY		6.3 - 7.0	0.6 - 4.0	16.5	29.0	18.0	151-01294

All dimensions in mm. Subject to technical changes.

Connector Clips

Connector Interface –
Type D5

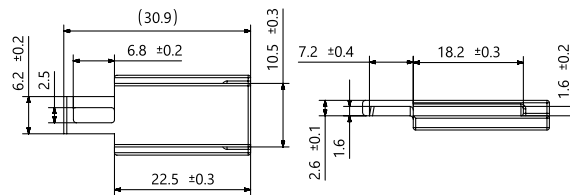
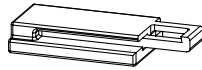

PART DESCRIPTION	Drawing	for Hole Ø (FH)	Panel Thickness	Height (H)	Length (L)	Width (W)	Article-No.
Connector Clip, oval hole, fir tree							
CC5AHOVAL7X12-PA66HIRHSUV-BK		7.0 x 12.0	1.4 - 1.6	16.6	32.0	16.0	151-02564
CC5AHOVAL7X12CLIP-PA66HIRHSUV-BK		7.0 x 12.0	1.4 - 1.6	16.6	32.0	16.0	151-02792

All dimensions in mm. Subject to technical changes.

Connector Clips

Connector Interface –
Type D7

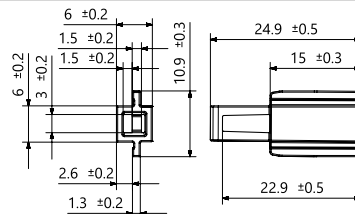
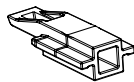

PART DESCRIPTION	Drawing	for Hole Ø (FH)	Panel Thickness	Height (H)	Length (L)	Width (W)	Article-No.
Connector Clip, round hole, arrow head							
CC32KHSFT6.5-PA66HIRHS-BK		6.5 - 7.0	1.7 - 2.3	15.0	25.0	16.3	151-03180

All dimensions in mm. Subject to technical changes.

Connector Clips

Connector Interface –
Type E1

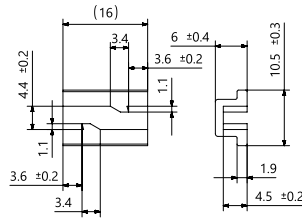
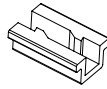

PART DESCRIPTION	Drawing	for Hole Ø (FH)	Panel Thickness	Bundle Ø max.	Stud Ø	Height (H)	Length (L)	Width (W)	Article-No.
Connector Clip, edge									
EC33-PA66HIRHS-BK		-	1.0 - 3.0	-	-	12.5	19.0	16.0	151-00192
EC28-PA66HIRHS-BK		-	1.0 - 3.0	-	-	16.3	16.0	9.5	151-00151
Connector Clip, on wire									
CCWA3.4-PA66HIRHS-BK		-	-	3.4	-	10.5	18.5	16.8	151-01876
CCWA4.5-PA66HIRHS-BK		-	-	4.5	-	10.5	18.5	17.9	151-01392
Connector Clip, oval hole, arrow head									
AMPKSFT62x122-90PT0.7-1.3-PA66HIRHS-BK		6.3 x 12.2	0.7 - 1.3	-	-	12.8	21.0	16.0	151-02268
CCSFT7x12-PA66HIRHS-BK		7.0 x 12.0	0.8 - 2.0	-	-	17.6	17.5	17.5	151-00194
CCAMPSFT7.0x12.0-PA66HIRHS-BK		7.0 x 12.0	1.2 - 2.0	-	-	17.6	16.0	16.0	155-43802
Connector Clip, oval hole, fir tree									
CCPAEDOP6.0x12.0-PA66HIRHS-BK		6.2 x 12.2	0.6 - 6.0	-	-	17.5	20.0	22.5	133-01073
Connector Clip, round hole, arrow head									
CC-PAEKSFT65PT06-13-PA66HIRHS-BK		6.3 - 6.7	0.6 - 1.3	-	-	13.4	16.0	16.0	151-01080
CC-PAEKSFT6.5PT1.7-2.3-PA66HIRHS-BK		6.3 - 6.7	1.7 - 2.3	-	-	13.4	16.0	16.0	151-00840

All dimensions in mm. Subject to technical changes.

Connector Clips

Connector Interface –
Type E1

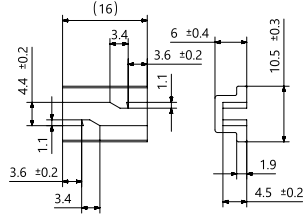
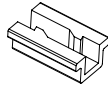

PART DESCRIPTION	Drawing	for Hole Ø (FH)	Panel Thickness	Bundle Ø max.	Stud Ø	Height (H)	Length (L)	Width (W)	Article-No.
Connector Clip, round hole, fir tree									
STECKERHALTER SITZ- PA66HIRHS-BK		6.5 - 7.0	0.6 - 3.0	-	-	15.2	33.5	10.3	155-36002
FT6LG-AMP-PA66HIRHS-BK		6.5 - 7.0	0.7 - 6.0	-	-	20.5	16.0	16.0	155-03800
FT6LG.M.AMP-AUFN.2- PA66HIRHS-BK		6.5 - 7.0	0.7 - 6.0	-	-	20.5	33.0	16.0	155-10801
CCPAEFT8G-PA66/6HIRHS-BK		8.0 - 8.5, M10	1.5 - 4.0	-	-	19.1	16.0	16.0	151-03391
Connector Clip, stud size 5 mm									
CCSBS5-PA66HIRHS-BK		-	-	-	5.0	20.0	16.0	10.8	151-01196

All dimensions in mm. Subject to technical changes.

Connector Clips

Connector Interface –
Type E2

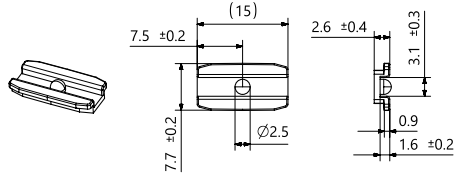

PART DESCRIPTION	Drawing	for Hole Ø (FH)	Panel Thickness	Height (H)	Length (L)	Width (W)	Article-No.
Connector Clip, edge							
CCIIEC6-MOD-PA66HIRHS-BK		-	1.0 - 3.0	13.9	7.8	9.4	151-01124
Connector Clip, oval hole, arrow head							
CCII SFT6.5x13-PA66HIRHS-BK		6.5 x 13.0	0.7 - 3.0	13.2	19.6	14.5	151-02269

All dimensions in mm. Subject to technical changes.

Connector Clips

Connector Interface –
Type E3

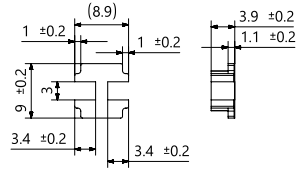

PART DESCRIPTION	Drawing	for Hole Ø (FH)	Panel Thickness	Height (H)	Length (L)	Width (W)	Article-No.
FT6LG2CT2-MOD-PA66HIRHS-BK		6.5 - 7.0	0.7 - 5.1	17.9	16.5	16.5	151-01127
Connector Clip, edge							
EC45-PA66HIRHS-BK		-	1.0 - 3.0	15.35	15.0	12.5	151-00460
EC JAE CC-PA66HIRHS-BK		-	1.0 - 3.0	15.8	15.0	9.0	151-00472
EC32-PA66HIRHS-BK		-	1.0 - 3.0	25.7	15.0	19.1	151-01862
Connector Clip, round hole, fir tree							
FT6LG.JAE.CONNECT.TS-PA66HIRHS-BK		6.5 - 7.0	0.7 - 5.1	17.9	24.0	16.0	151-00459

All dimensions in mm. Subject to technical changes.

Connector Clips

Connector Interface –
Type E5

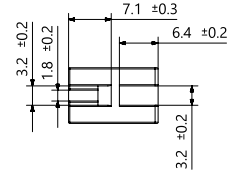
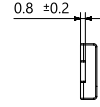
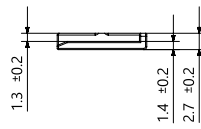
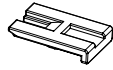

PART DESCRIPTION	Drawing	for Hole Ø (FH)	Panel Thickness	Height (H)	Length (L)	Width (W)	Article-No.
Connector Clip, oval hole, arrow head, sealed							
CC9SFT7x12-MD-PA66HIRHS-BK		7.0 x 12.0	0.7 - 1.5	13.7	25.0	19.0	151-02656
Connector Clip, round hole, arrow head							
CC11SFT712-PA66HIRHS-BK		7.0 x 12.0	1.8 - 2.8	14.2	27.2	17.4	151-03002

All dimensions in mm. Subject to technical changes.

Connector Clips

Connector Interface –
Type E6

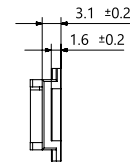
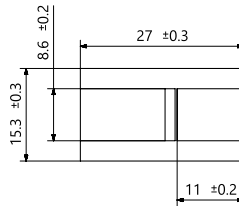
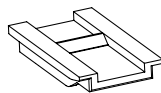

PART DESCRIPTION	Drawing	for Hole Ø (FH)	Panel Thickness	Height (H)	Length (L)	Width (W)	Article-No.
Connector Clip, round hole, fir tree							
CC-V1FT6-PA66HIRHS-BK		6.1 - 6.9	0.6 - 5.0	27.0	18.9	15.6	151-01618

All dimensions in mm. Subject to technical changes.

Connector Clips

Connector Interface –
Type F1

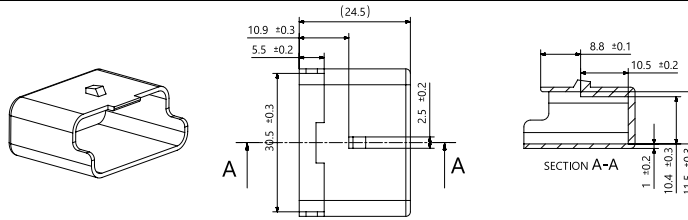

PART DESCRIPTION	Drawing	for Hole Ø (FH)	Panel Thickness	Height (H)	Article-No.
Connector Clip, oval hole, fir tree					
CP61DOP-PA66HIRHS-BK		6.2 x 12.2	0.60 - 5.00	26.8	151-00918
Connector Clip, round hole, fir tree					
CP6FT6-PA6HIR-BK		6.2 - 6.5	0.7 - 5.0	25.5	151-00162

All dimensions in mm. Subject to technical changes.

Connector Clips

Connector Interface –
Type F2

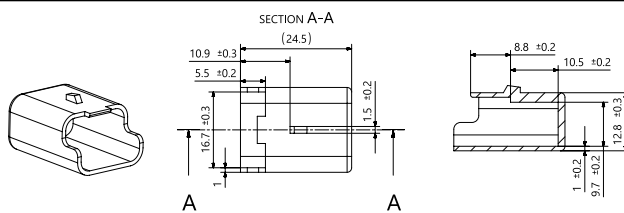

PART DESCRIPTION	Drawing	for Hole Ø (FH)	Panel Thickness	Height (H)	Article-No.
Connector Cap					
CP3FT6-PA66HIRHS-BK		6.2 - 6.5	0.7 - 5.0	24.9	151-00163
CP31DOP-PA66HIRHS-BK		6.2 x 12.2	0.6 - 5.0	26.1	151-00214

All dimensions in mm. Subject to technical changes.

Connector Clips

Connector Interface –
Type F3

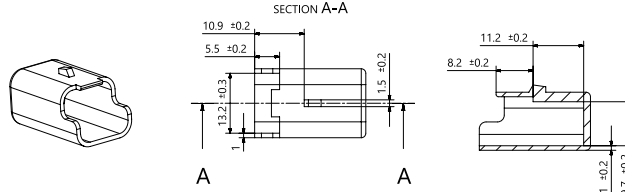

PART DESCRIPTION	Drawing	for Hole Ø (FH)	Panel Thickness	Height (H)	Article-No.
Connector Cap					
CP2FT6-PA66HIRHS-BK		6.2 - 6.5	0.7 - 5.0	23.9	151-00216
CP2FT6-PA46-GY		6.2 - 6.5	0.70 - 5.00	23.9	151-00914
CP21DOP-PA66HIRHS-BK		6.2 x 12.2	0.6 - 5.0	26.1	151-00465
CP21DOP-PA46-GY		6.2 x 12.2	0.60 - 5.00	26.1	151-00915

All dimensions in mm. Subject to technical changes.

Connector Clips

Connector Interface –
Type F4

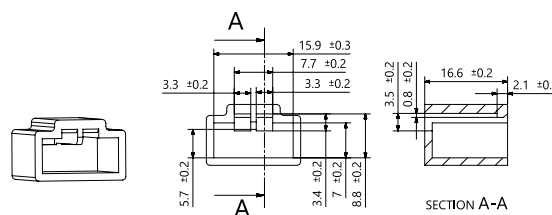

PART DESCRIPTION	Drawing	Panel Thickness	Height (H)	Length (L)	Width (W)	Article-No.
Connector Cap						
Edge-Clip25-PA66HIRHS-BK		1.0 - 3.0	23.8	18.9	19.6	133-00075

All dimensions in mm. Subject to technical changes.

Connector Clips

Connector Interface –
Type G2

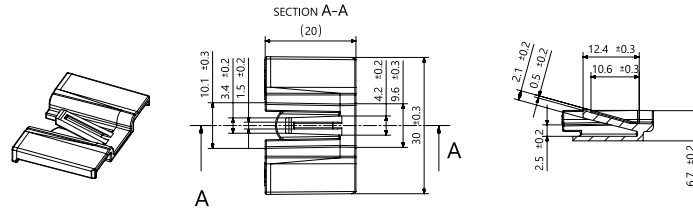

PART DESCRIPTION	Drawing	for Hole Ø (FH)	Panel Thickness	Height (H)	Length (L)	Width (W)	Article-No.
Connector Clip, oval hole, fir tree							
CC12-PA66HIRHSUV-BK		8.0 x 15.0	0.6 - 6.5	22.2	25.5	18.29	151-01136

All dimensions in mm. Subject to technical changes.

Connector Clips

Connector Interface –
Type G5

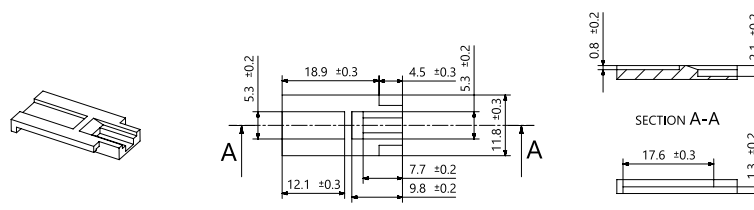

PART DESCRIPTION	Drawing	for Hole Ø (FH)	Panel Thickness	Height (H)	Length (L)	Width (W)	Article-No.
Connector Clip, oval hole, arrow head, sealed							
TCCSFT6.5X13PT0.6-2.0-MD-PA66HIRHS/EPDM-BK		6.5 x 13.0	0.6 - 2.0	15.8	23.4	16.0	151-01272
Connector Clip, round hole, arrow head							
CC19SFT7-PA66HIRHS-BK		-	2.3 - 3.0	17.4	21.4	6.3	151-02550
Connector Clip, round hole, arrow head, sealed							
CC19SFT7-MD-PA66HIRHS-BK		7.0	0.8 - 1.5	17.4	21.4	16.7	151-03204

All dimensions in mm. Subject to technical changes.

Connector Clips

Connector Interface –
Type G6

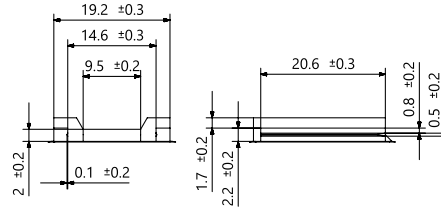
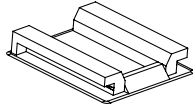

PART DESCRIPTION	Drawing	for Hole Ø (FH)	Panel Thickness	Height (H)	Length (L)	Width (W)	Article-No.
Connector Clip, oval hole, fir tree							
CCPAEBDOP6.0x12.0-PA66HIRHS-BK		6.2 x 12.2	0.6 - 6.0	16.9	29.0	26.0	133-03902

All dimensions in mm. Subject to technical changes.

Connector Clips

Connector Interface –
Type G7

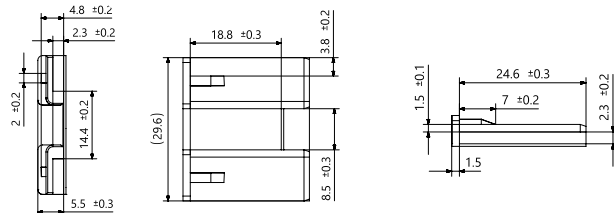
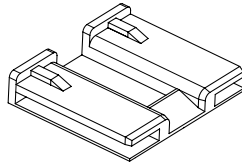

PART DESCRIPTION	Drawing	for Hole Ø (FH)	Panel Thickness	Height (H)	Length (L)	Width (W)	Article-No.
Connector Clip, oval hole, arrow head							
Halter CCSFT6.2x12.2-PA66HIRHS-BK		6.2 x 12.2	1.5 - 3.0	23.7	38.3	29.6	151-01464

All dimensions in mm. Subject to technical changes.

Connector Clips

Connector Interface –
Type H1

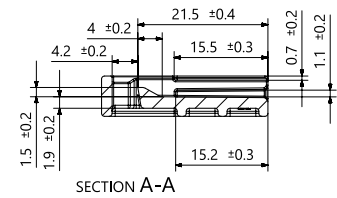
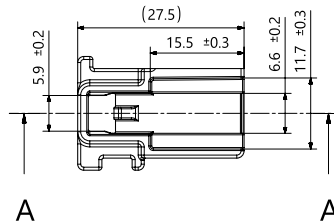
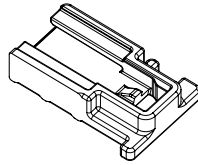

PART DESCRIPTION	Drawing	Bundling Bar Length	Height (H)	Length (L)	Width (W)	Article-No.
Bundling Clip, connector						
BCBRKT55M-PPS-SR		50.0	15.8	70.8	50.0	151-01537
BCBRKT55M-PA66HIRHS-NA		50.0	15.8	70.9	50.0	151-01404

All dimensions in mm. Subject to technical changes.

Connector Clips

Connector Interface –
Type J1

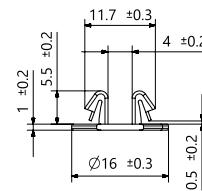
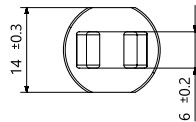

PART DESCRIPTION	Drawing	for Hole Ø (FH)	Panel Thickness	Height (H)	Length (L)	Width (W)	Article-No.
Connector Clip, round hole, arrow head							
CCSCSFT8-0.6-1.4-PA66HIRHS-BK		8.0	0.6 - 1.4	18.9	16.0	16.0	151-01171
Connector Clip, round hole, fir tree							
CCSC-FT10LG-PA66HIRHS-BK		10.0	1.5 - 6.7	23.9	22.0	22.0	151-02209

All dimensions in mm. Subject to technical changes.

Connector Clips

Connector Interface –
Type L1

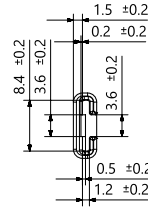
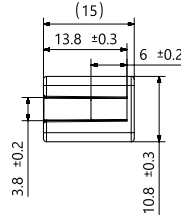
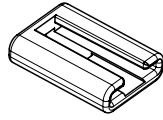

PART DESCRIPTION	Drawing	for Hole Ø (FH)	Panel Thickness	Height (H)	Length (L)	Width (W)	Article-No.
Connector Clip, oval hole, arrow head							
CCKSFT6.2x12.2-PA66HIRHSUV-BK		6.2 x 12.2	2.3 - 2.7	14.0	15.0	16.0	151-01003

All dimensions in mm. Subject to technical changes.

Connector Clips

Connector Interface –
Type L3

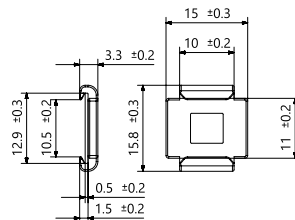
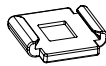

PART DESCRIPTION	Drawing	for Hole Ø (FH)	Panel Thickness	Height (H)	Length (L)	Width (W)	Article-No.
Connector Clip, oval hole, arrow head							
CCWPM712A-PA66HSW-BK		7.0 x 12.0	1.0 - 4.8	15.0	19.1	23.5	151-03215
CCWPM712B-PA66HSW-BK		7.0 x 12.0	6.0 - 12.0	15.0	27.3	25.5	151-03216

All dimensions in mm. Subject to technical changes.

Connector Clips

Connector Interface –
Type M1

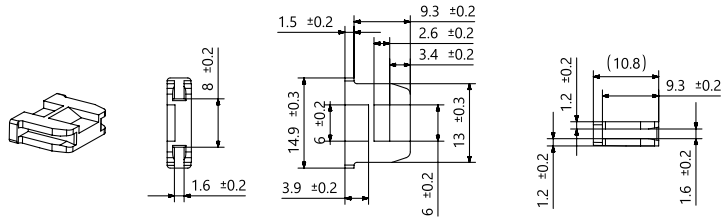

PART DESCRIPTION	Drawing	Stud Ø	Height (H)	Length (L)	Width (W)	Article-No.
Connector Clip, stud size 6 mm						
CCSBS6-PA66HIRHS-BK		6.0	18.6	16.0	10.8	151-01698

All dimensions in mm. Subject to technical changes.

Connector Clips

Connector Interface –
Type M2

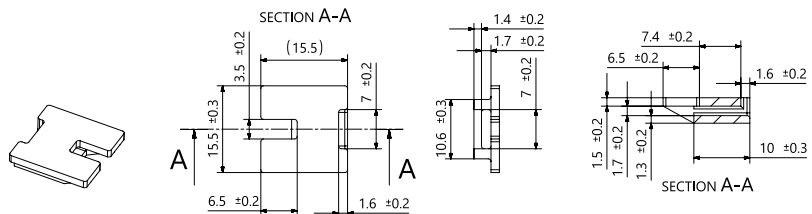

PART DESCRIPTION	Drawing	for Hole Ø (FH)	Panel Thickness	Height (H)	Length (L)	Article-No.
Connector Clip, round hole, arrow head						
Big Connector Clip-PA66HIRHS-BK		6.5 - 6.7	0.7 - 2.7	16.7	20.1	151-01837

All dimensions in mm. Subject to technical changes.

Connector Clips

Connector Interface –
Type N1

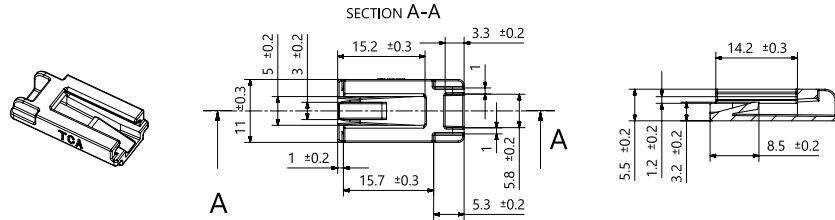

PART DESCRIPTION	Drawing	for Hole Ø (FH)	Panel Thickness	Height (H)	Length (L)	Width (W)	Article-No.
Connector Clip, oval hole, fir tree							
CCOVAL4-PA66HIRHSUV-BK		6.2 x 12.2, 6.5 x 12.5, 6.5 x 13.0, 7.0 x 12.0	0.6 - 6.75	21.6	23.6	17.6	151-01246

All dimensions in mm. Subject to technical changes.

Connector Clips

Connector Interface –
Type N2

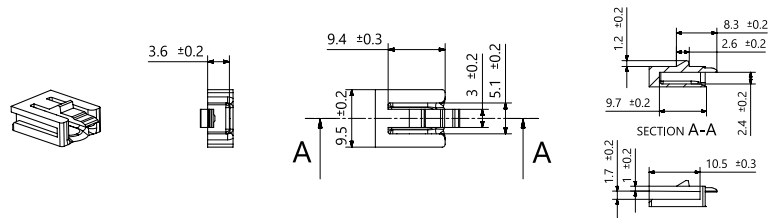

PART DESCRIPTION	Drawing	for Hole Ø (FH)	Panel Thickness	Height (H)	Length (L)	Width (W)	Article-No.
Connector Clip, oval hole, arrow head, sealed							
TCCSFT6.2x12.2-MD-PA66HIRHS/EPDM-BK		6.2 x 12.2	0.60 - 2.0	15.0	22.0	19.0	151-01254
Connector Clip, oval hole, fir tree							
CCFTOVAL-PA66HIRHS-BK		6.2 - 12.2, 6.5 x 12.5, 6.5 x 13.0, 7.0 x 12.0	0.6 - 6.75	19.3	22.0	16.0	151-01057

All dimensions in mm. Subject to technical changes.

Connector Clips

Connector Interface –
Type N3

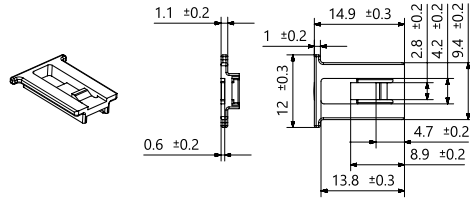

PART DESCRIPTION	Drawing	for Hole Ø (FH)	Panel Thickness	Height (H)	Length (L)	Width (W)	Article-No.
Connector Clip, oval hole, fir tree							
CCFTOVAL-Big-Slot-PA66HIRHS-BK		6.2 x 12.2, 6.5 x 12.5, 6.5 x 13.0, 7.0 x 12.0	0.6 - 4.0	16.8	23.6	17.6	151-02654

All dimensions in mm. Subject to technical changes.

Connector Clips

Connector Interface –
Type P1

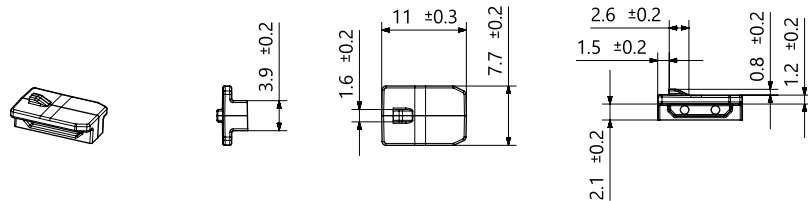

PART DESCRIPTION	Drawing	for Hole Ø (FH)	Panel Thickness	Height (H)	Length (L)	Width (W)	Article-No.
Connector Clip, oval hole, fir tree							
CCOVAL5-PA66HIRHSUV-BK		6.2 x 12.2, 6.5 x 12.5, 6.5 x 13.0, 7.0 x 12.0	0.6 - 6.75	19.55	23.6	17.6	151-01286

All dimensions in mm. Subject to technical changes.

Connector Clips

Connector Interface –
Type R5

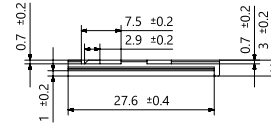
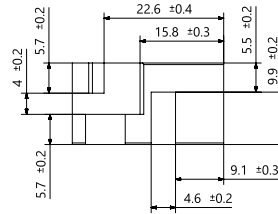
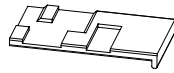

PART DESCRIPTION	Drawing	for Hole Ø (FH)	Panel Thickness	Height (H)	Length (L)	Width (W)	Article-No.
Connector Clip, round hole, fir tree							
Big YCC TS-PA66HIRHS-BK		6.4 - 7.1	0.7 - 5.1	15.7	28.6	16.0	151-02273

All dimensions in mm. Subject to technical changes.

Connector Clips

Connector Interface –
Type R6

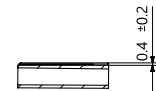
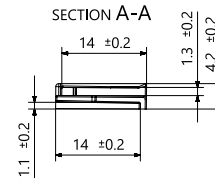
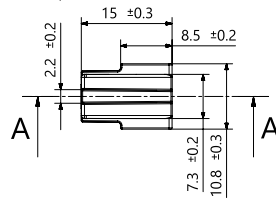
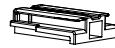

PART DESCRIPTION	Drawing	for Hole Ø (FH)	Panel Thickness	Height (H)	Length (L)	Width (W)	Article-No.
Connector Clip, oval hole, arrow head							
CCSFT8.5X16-PA66HIRHS-BK		8.5 x 16.0	0.7 - 1.5	15.0	19.5	18.5	151-01004

All dimensions in mm. Subject to technical changes.