

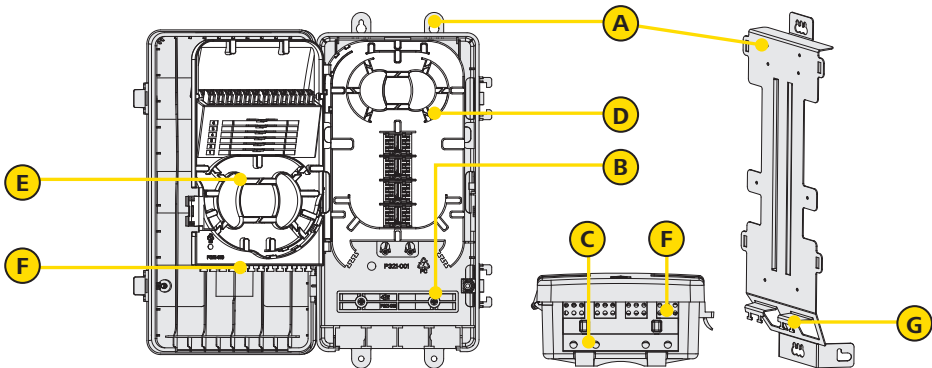

Aerial Fibre Node (AFN)

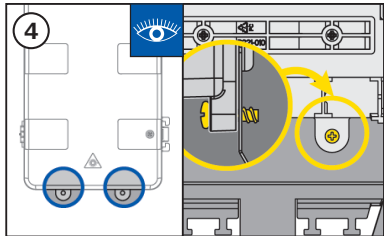

A

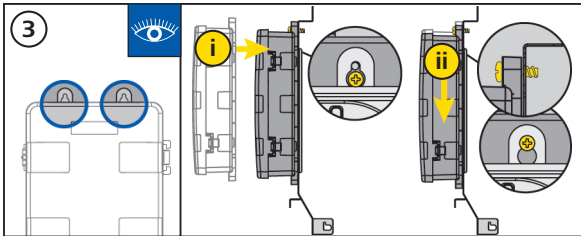
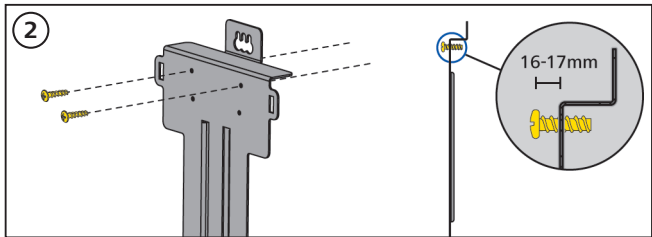
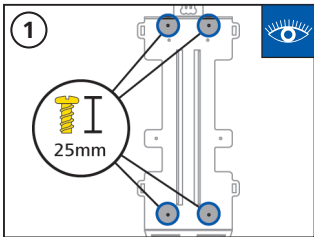

B

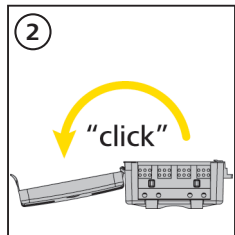
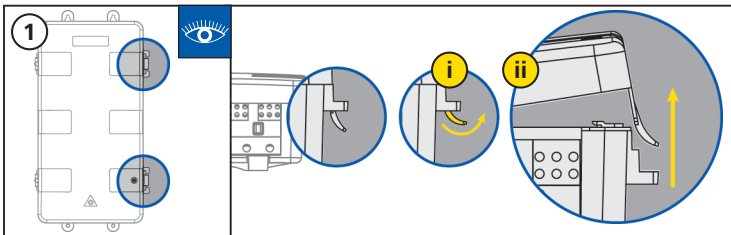

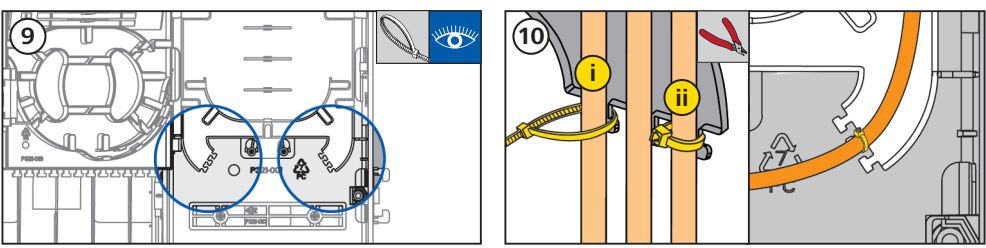
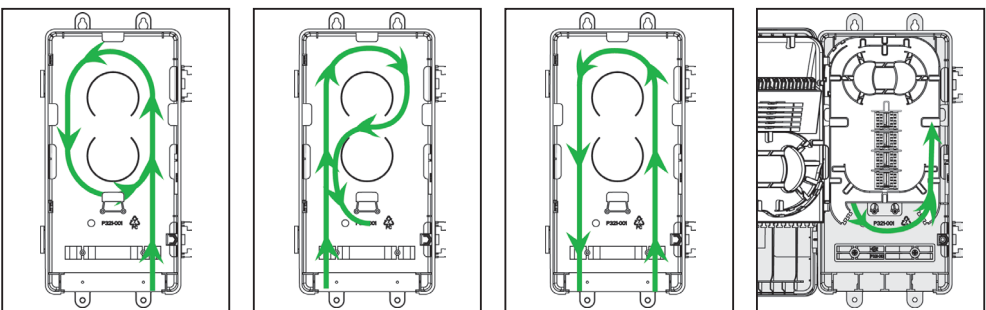
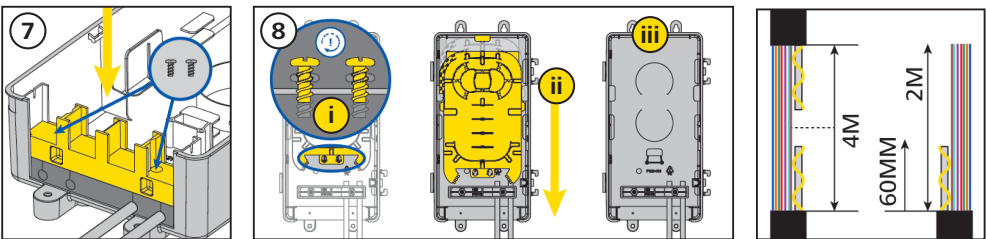
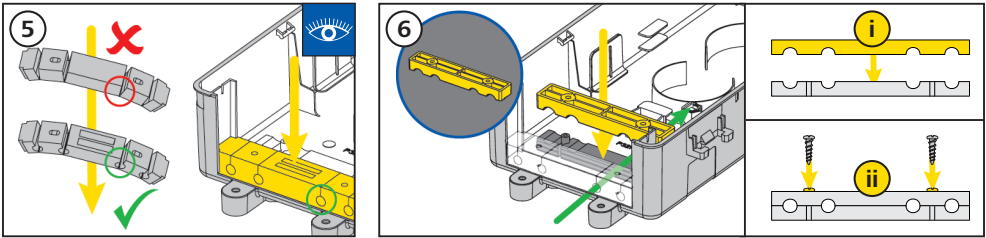
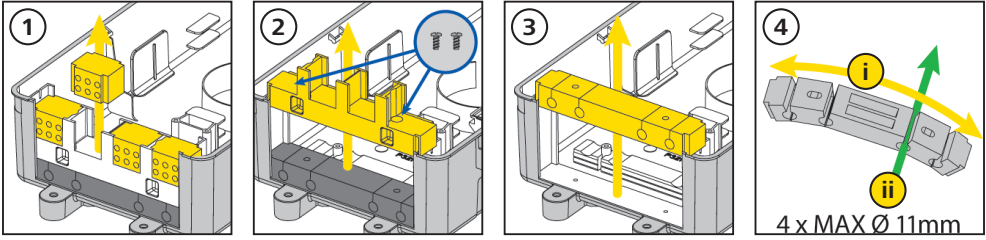

D

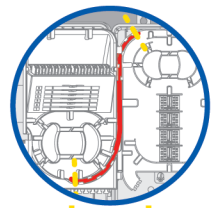
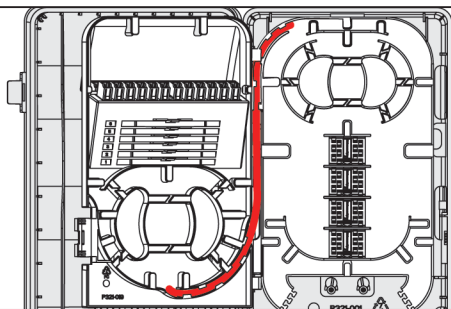
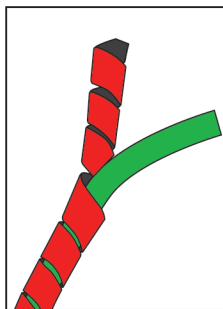
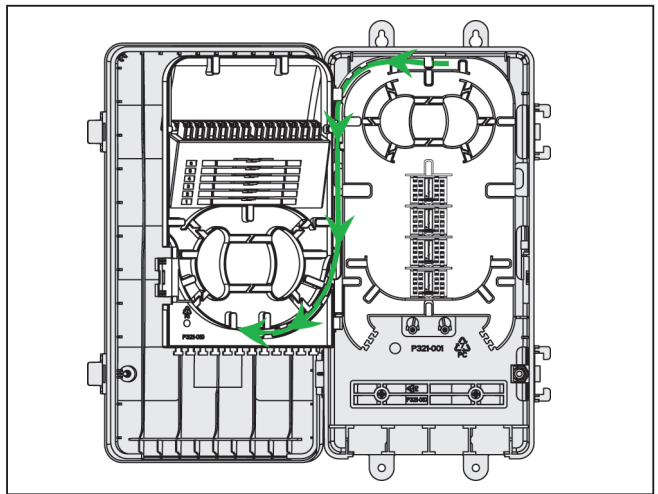
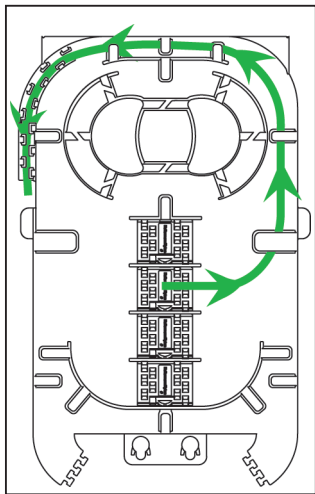
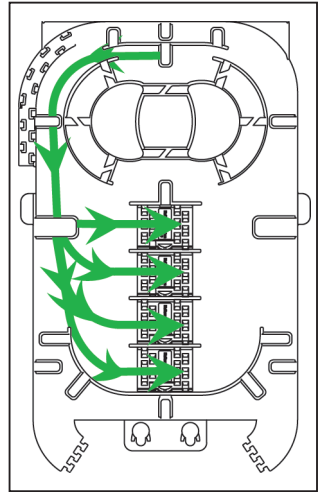
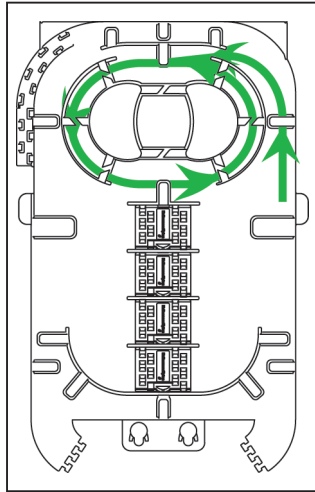
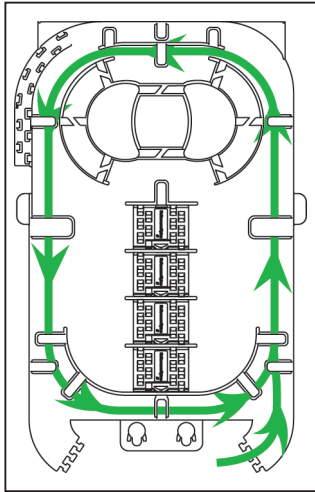

280mm
24 x 600µm MAX.

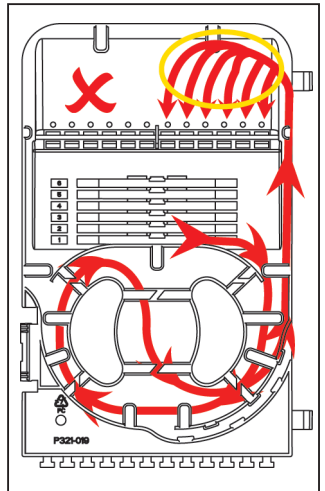
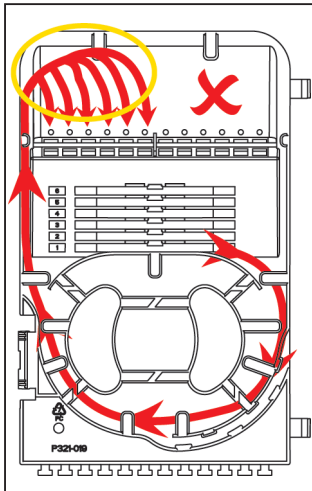
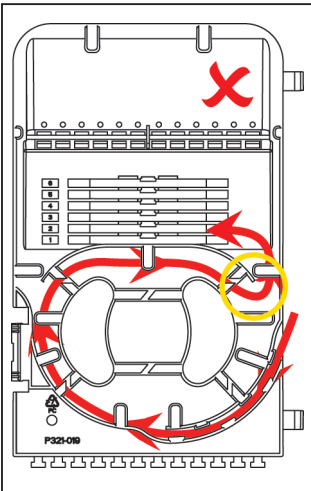
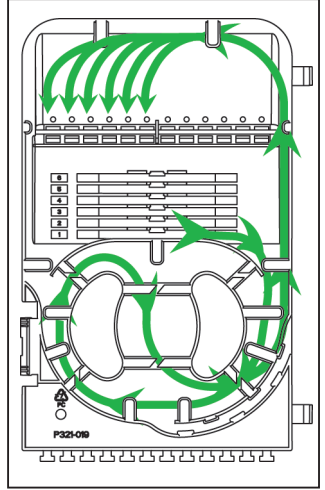
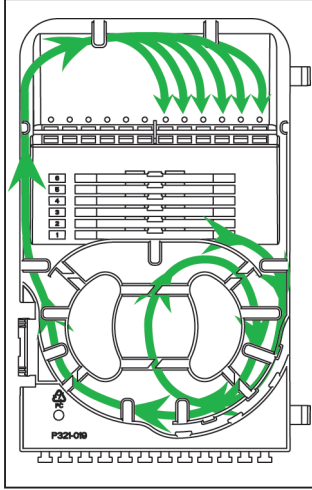
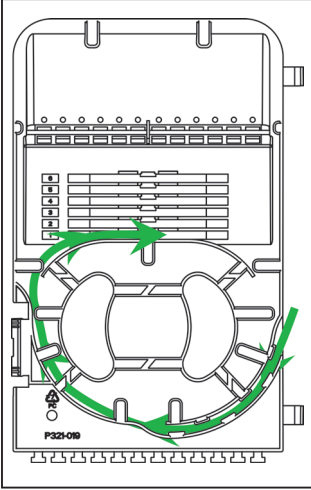
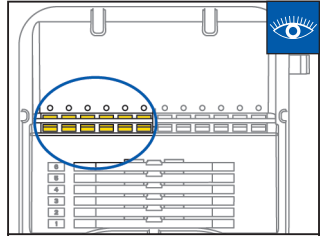
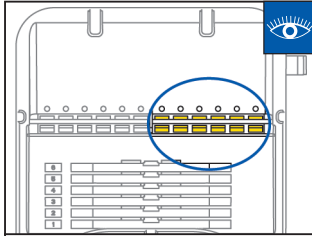
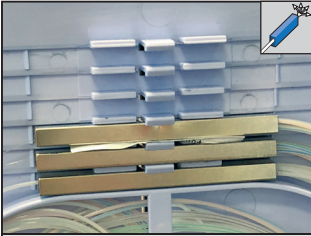

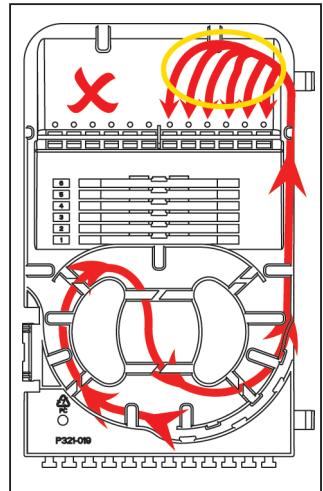
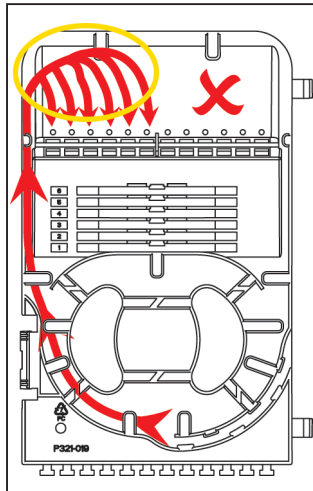
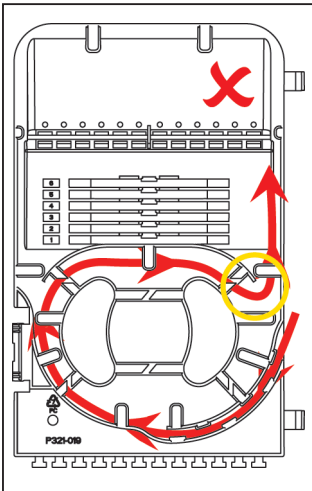
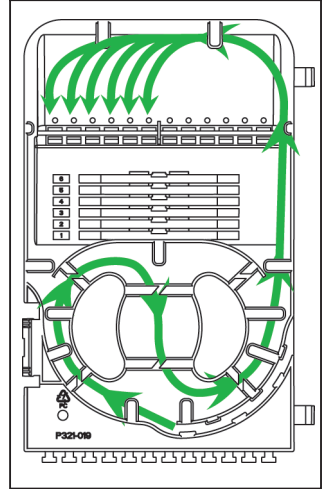
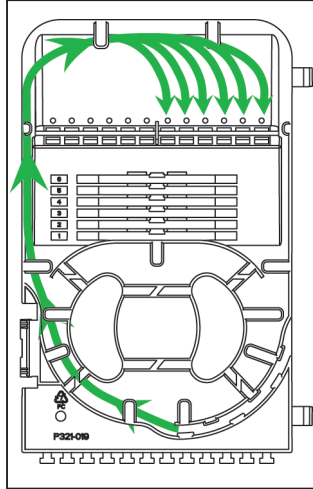
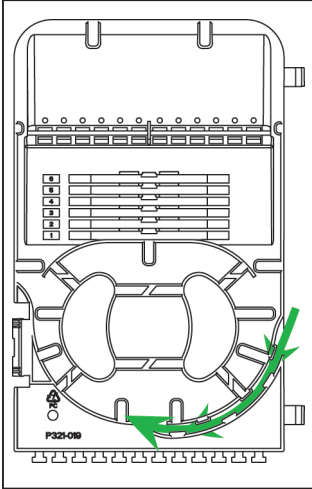
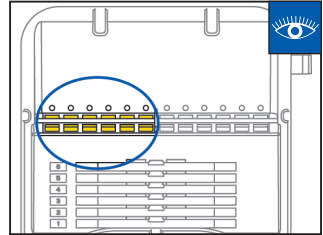
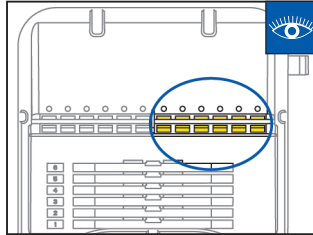
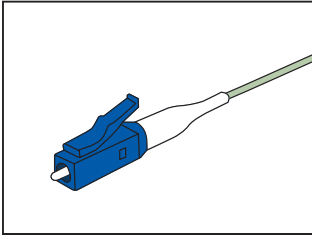

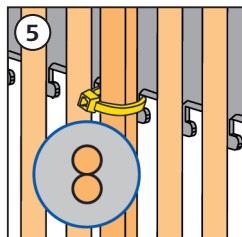
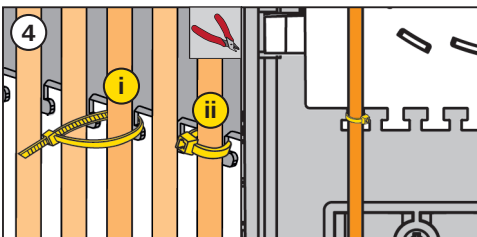
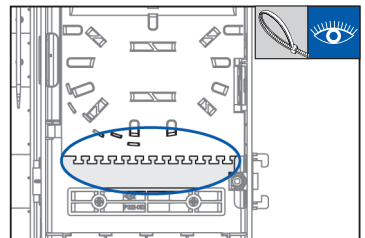
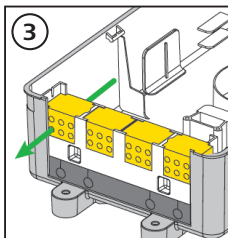
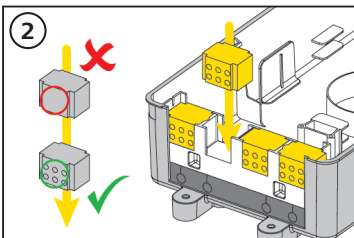
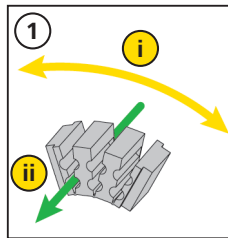
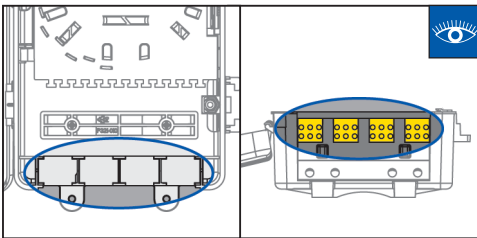
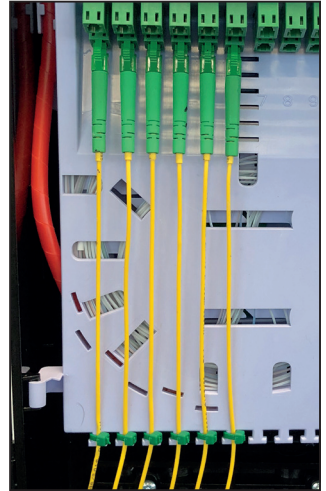
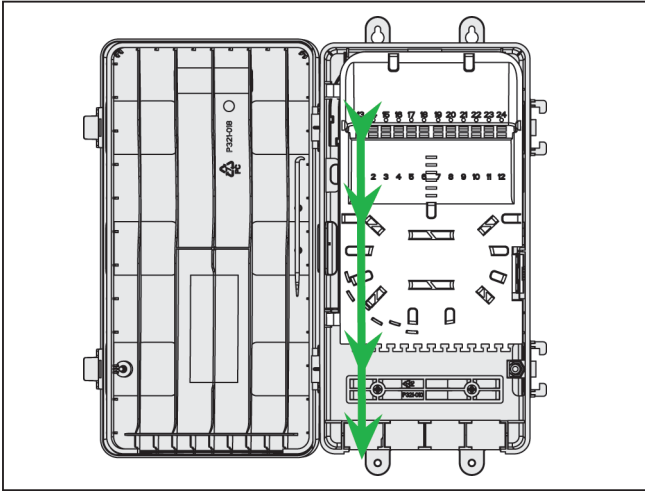

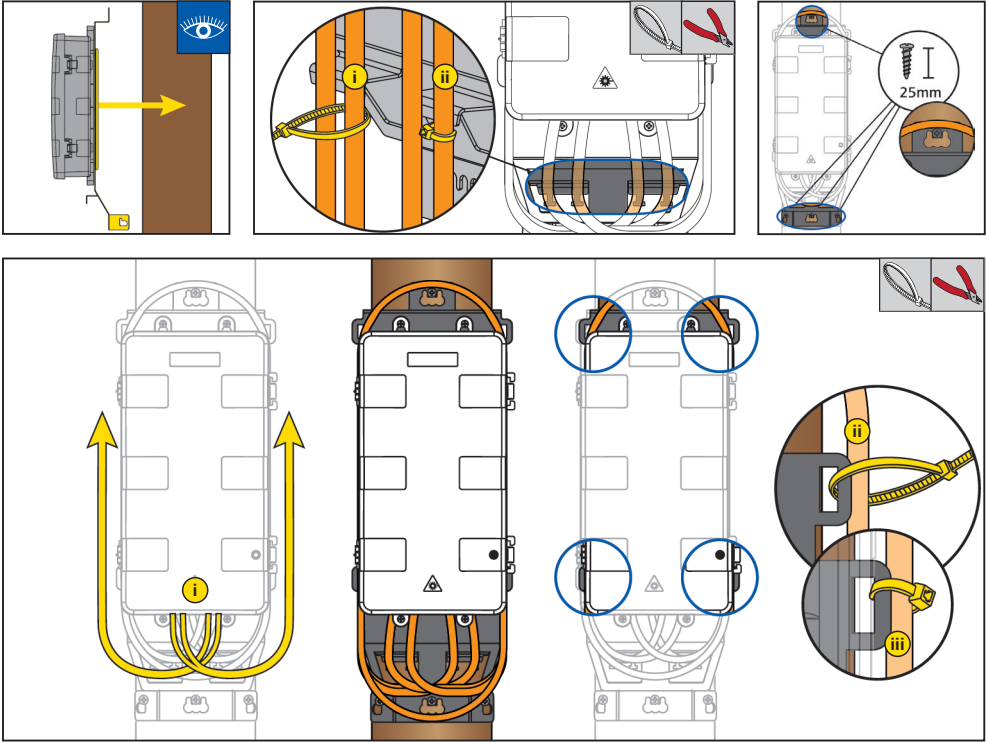

HellermannTyton

Tel: +44 (0) 1604 706633
www.htdata.co.uk

Stay in touch with us!

