



Solutions for automatic bundling systems

Overview of ATS Fixing Elements / ATS Bundling Clips



Creating effective and reliable bundling processes

HellermannTyton is a market leader in the field of automatic cable tying processes. We have been developing and optimising our Autotools in close cooperation with customers since 1990.

Automating bundling, threading, tightening and cutting of cable ties can be used in several industrial productions.

With the high bundling speeds, the individually adjustable parameters and the high process reliability of the Autotools, production processes can be designed to be efficient.

As a developer and manufacturer of these Autotool systems, HellermannTyton has extensive experience in the implementation of automation projects together with system developers.

We are happy to support you in project planning with all the data you need as well as personal and professional consultation right from the start.

A strong partnership with us is your path to success.
Please do not hesitate to contact us!

MADE FOR REAL[®]

Automating ATS Fixing Elements and Bundling Clips

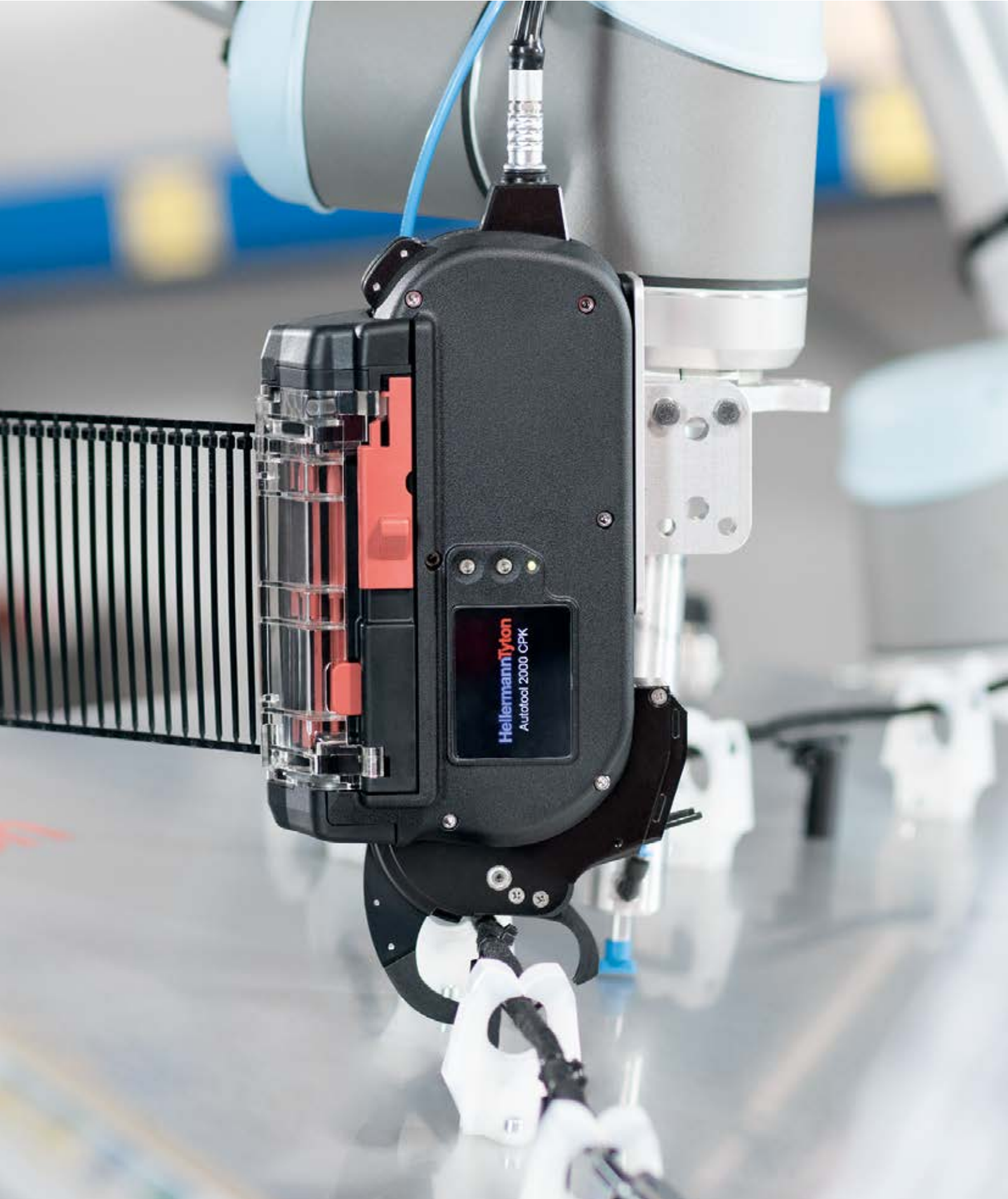



Application Tooling

HellermannTyton offers two different automatic tool options - the Autotool System 3080 and the Autotool 2000 CPK. The tools work fully automatically and considerably accelerate the cable tying processes. Bundling, threading, tensioning and cutting are done at the touch of a button – with constant quality. They make faster and more effective processing possible.

Waste-free bundling up to Ø 80 mm

Autotool System 3080

Features and benefits:

- Cycle time: 1.1-2.4 seconds, depending on bundle diameter
- Bundle diameters up to 80 mm
- Outside-serrated strap protects the bundle from damage
- No strap wastage thanks to separate closure head
- Includes three quickly changeable jaw sizes with diameters of 30 mm, 50 mm and 80 mm
- Consumables are available on reels of 500 m strap and of 5,000 pieces closures – ideal for large-scale production



Autotool System 3080.

TYPE	Description	Article-No.
ATS3080	Autotool System 3080	102-00000
Power pack 3080	Power pack 3080	102-00100
SP 3080 upper jaw 50mm foot parts cpl.	Autotool System 3080	102-55100
SP 3080 lower jaw 50mm foot parts cpl.	Autotool System 3080	102-55200

Subject to technical changes.

Automatic bundling up to Ø 20 mm

Autotool 2000 CPK

Features and benefits:

- Cycle times: 0.8-1.2 seconds per setting depending on quality and force
- Bundle diameters up to 20 mm
- Includes „HT Data Management“ software for complete documentation of each repetitive cable tie processed
- Special functions by software, e.g. definition of the bundle diameter independent of the bundle size
- Processing of bandoleers of 50 cable ties or reels of 3,500 cable ties



Autotool 2000 CPK.

TYPE	Description	Article-No.
Autotool 2000 CPK	Autotool 2000 CPK	106-00000
Power pack CPK	Power pack CPK	106-00100
Power pack CPK with control box	Power pack CPK with control box	106-00110

Subject to technical changes.

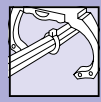

Fixing Elements for Autotool System 3080

The product family ATS-Fixing Elements was tailor-made for automated processing with the ATS3080. The required pair of jaws is specially adapted to their geometry and can be mounted on the ATS3080 in a few simple steps. The bundle diameter is then limited to 50mm.

With this pair of jaws, the ATS3080 can grip the Fixing Element on the retainer, loop in the endless strap, tighten it on the bundle good and cut it off flush with the set tension on the cable tie head.

The result is a waste-free binding of a Fixing Element to the bundled goods.



Edge Clips for Autotool System 3080



PART DESCRIPTION	Drawing	Panel Thickness
ATS-Clip, edge		
ATS-EC9-PA66HIRHS-BK		1.0 - 3.0
ATS-EC21-PA66HIRHS-BK		1.0 - 3.0
ATS-EC22-PA66HIRHS-BK		1.0 - 3.0
ATS-EC10-PA66HIRHS-BK		1.0 - 3.0
ATSEC35-PA66HIRHS-BK		1.5 - 4.0
ATSEC36-PA66HIRHS-BK		1.5 - 4.0
ATSEC37-PA66HIRHS-BK		1.5 - 4.0
ATSEC38-PA66HIRHS-BK		1.5 - 4.0
ATSEC19-PA66HIRHS-BK		3.0 - 6.0

All dimensions in mm. Subject to technical changes. Availability on request.

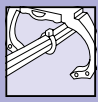
i Other dimensions/variants available on request!
For more information please contact us!

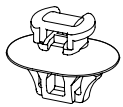
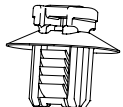

Clips for holes for Autotool System 3080

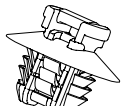
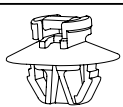
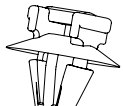
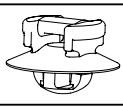
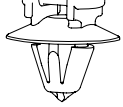
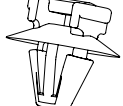
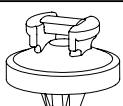
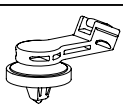
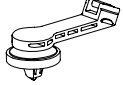
PART DESCRIPTION	Drawing	for Hole Ø (FH)	Panel Thickness	Offset Length
ATS-Clip, oval hole, arrow head				
ATS-SFT712S-PA66HIRHS-BK		7.0 x 12.0	0.5 - 2.6	-
ATS-Clip, oval hole, fir tree				
ATS62x122-2DOP-PA66HIRHS-BK		6.2 x 12.2	0.6 - 6.0	-
ATS62x122-2DOP90-PA66HIRHS-BK		6.2 x 12.2	0.6 - 6.0	-
ATS-FTOVAL-PA66HIRHS-BK		6.2 x 12.2, 6.5 x 12.5, 6.5 x 13.0, 7.0 x 12.0	0.6 - 4.5	-
ATS-FT7x12S-PA66HIRHS-BK		7.0 x 12.0	0.6 - 3.2	-
ATS-Clip, round hole, arrow head				
ATS-SFT5-PA66HIRHS-BK		4.8 - 5.2	0.6 - 1.5	-
ATS-KSFT6.5-PA66HIRHS-BK		6.3 - 6.7	0.7 - 1.3	-
ATS-SFT6.5E-PT0.7-1.6-PA66HIRHS-BK		6.3 - 6.7	0.7 - 1.6	-
ATS-SFT7-PA66HIRHS-BK		6.8 - 7.2	0.6 - 1.8	-
ATS-Clip, round hole, arrow head, sealed				
ATS-SFT6.5E-MD-PA66HIRHS-BK		6.3 - 6.7	0.7 - 1.6	-
ATS-SFT6.5ESO12.5A-MD-PA66HIRHS-BK		6.3 - 6.7	0.7 - 1.6	12.5
ATS-SFT6.5ESO15A-MD-PA66HIRHS-BK		6.3 - 6.7	0.7 - 1.6	15.0
ATS-SFT6.5ESO25A-MD-PA66HIRHS-BK		6.3 - 6.7	0.7 - 1.6	25.0

All dimensions in mm. Subject to technical changes. Availability on request.

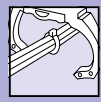

PART DESCRIPTION	Drawing	for Hole Ø (FH)	Panel Thickness	Offset Length
ATS-Clip, round hole, fir tree				
ATS-FT4-PA66HIRHS-BK		3.3 - 4.0	1.0 - 3.0	-
ATSFT5LG-PA66HIRHS-BK		4.5 - 5.0	0.7 - 8.0	-
ATSFT612.5SO-PA66HIRHS-BK		6.1 - 6.9	0.6 - 4.0	12.5
ATS-FT6SO12.5A-PA66HIRHS-BK		6.3 - 6.7, 6.1 - 6.6 (hexagonal)	0.6 - 6.65	12.5
ATS-FT6SO25A-PA66HIRHS-BK		6.3 - 6.7, 6.1 - 6.6 (hexagonal)	0.6 - 6.65	25.0
ATSFT6-PA66HIRHS-BK		6.3 - 7.0	0.75 - 3.0	-
ATSFT6LG-PA66HIRHS-BK		6.5 - 7.1	0.6 - 6.0	-
ATS-FT7-PA66HIRHS-BK		6.8 - 7.2	0.6 - 4.5	-
ATSFT8GSD-PA66HIRHS-BK		8.0 - 8.5	1.5 - 4.0	-

All dimensions in mm. Subject to technical changes. Availability on request.

i Other dimensions/variants available on request!
For more information please contact us!

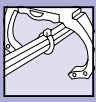

Adhesive Clips for Autotool System 3080

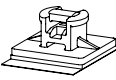
PART DESCRIPTION	Drawing	Length (L)	Width (W)
ATS-Clip, adhesive mount			
ATS-MB3APT-A-PA66HIRHS-BK		24.0	19.0

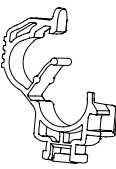

All dimensions in mm. Subject to technical changes. Availability on request.

Harness Clips for Autotool System 3080

PART DESCRIPTION	Drawing	Bundle Ø min.	Bundle Ø max.
Harness Clip (3), closeable			
ATSLOC5-9-PA66HIRHS-BK		5.0	9.0

All dimensions in mm. Subject to technical changes. Availability on request.

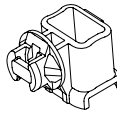
Stud Clips for Autotool System 3080

PART DESCRIPTION	Drawing	Stud Ø
ATS-Clip, stud		
ATS SB5-6-PA66HIRHS-BK		5.0, 6.0
ATS-SB5-6HE-PA66HIRHS-BK		5.0, 6.0

All dimensions in mm. Subject to technical changes. Availability on request.

i Other dimensions/variants available on request!
For more information please contact us!

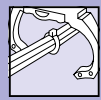

Bundling Clips for Autotool System 3080 and Autotool 2000 CPK

The product family ATS-Bundling Clips with one or two bars can be tied with both the Autotool Systems 3080 and the Autotool 2000 CPK. This specially developed clip family has a so-called anti slip serration, which ensures additional hold of the cable tie on the bundling clip. The respective Autotool guides the strap of the cable tie around the bar, pulls it tight with the set tension and cuts it off at the cable tie head. A secure setting is created with a Bundling Clip on the bundled goods.



Bundling Clips for Autotool System 3080 and Autotool 2000 CPK

PART DESCRIPTION	Drawing	for Hole Ø (FH)	Panel Thickness	Bundling Bar Length	Offset Length
Bundling Clip, edge					
ATSBC-SP-EC1-3-PA66HIRHS-BK		-	1.0 - 3.0	39.0	-
ATSBC-TP-EC1-3-PA66HIRHS-BK		-	1.0 - 3.0	39.0	-
ATSBC-SV-EC1-3-PA66HIRHS-BK		-	1.0 - 3.0	39.0	-
ATSBCEC35-PA66HIRHS-BK		-	1.5 - 4.0	39.0	-
ATSBCEC36-PA66HIRHS-BK		-	1.5 - 4.0	39.0	-
ATSBCEC37-PA66HIRHS-BK		-	1.5 - 4.0	39.0	-
ATSBCEC38-PA66HSW-BK		-	1.5 - 4.0	39.0	-
Bundling Clip, oval hole, fir tree, offset					
ATSBCSOC6.2x12.2-PA66HIRHS		6.0 x 12.2	0.6 - 6.0	42.0	15.0

All dimensions in mm. Subject to technical changes. Availability on request.



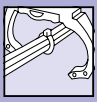

Bundling Clips for Autotool System 3080 and Autotool 2000 CPK

PART DESCRIPTION	Drawing	for Hole Ø (FH)	Panel Thickness	Bundling Bar Length	Offset Length
Bundling Clip, round hole, arrow head					
ATSBCKSFT6.5-PA66HIRHS-BK		6.3 - 6.7	0.7 - 1.3	39.0	-
ATSBK2KSFT6.5-PA66HIRHS-BK		6.3 - 6.7	1.7 - 2.3	39.0	-
ATSBKOW2SFT6.5-PA46/PA46-GY		6.3 - 6.7	2.3 - 3.3	27.5	-
ATSBKOWSFT6.5-PA46-GY		6.3 - 6.7	2.3 - 3.3	27.5	-
ATSBKSFT6.5-PA66HIRHS-BK		6.3 - 6.7	2.3 - 3.3	39.0	-
ATSBKSFT6.5PT2.3-3.3-PA46-GY		6.3 - 6.7	2.3 - 3.3	39.0	-
Bundling Clip, round hole, arrow head, sealed					
ATSBKSFT6.5-MD-PA66HIRHS-BK		6.3 - 6.7	2.0 - 3.0	39.0	-
Bundling Clip, round hole, fir tree					
ATSBKFT6LG-PA66HIRHS-BK		6.3 - 7.0	0.6 - 5.1	39.0	-

All dimensions in mm. Subject to technical changes. Availability on request.



Other dimensions/variants available on request!
For more information please contact us!

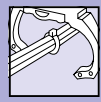

Material Specification Overview

HellermannTyton manufactures a large range of fastenings and fixings made from different raw materials to suit particular applications and environments. The overview below shows a selected range of these materials including technical information, material properties and material specifications.

MATERIAL	Material Shortcut	Operating Temperature
Polyamide 4.6	PA46	-40 °C to +150 °C, (+195 °C, 500 h)
Polyamide 6.6, high impact modified, heat stabilised	PA66HIRHS	-40 °C to +105 °C
Polyamide 6.6, heat and UV-resistant	PA66HSW	-40 °C to +105 °C

Operating Temperature refers to the raw material being used.

Tip: Material shortcut is part of our Part Description name

Product series name (indicating tie type, clip and harness routing variant)

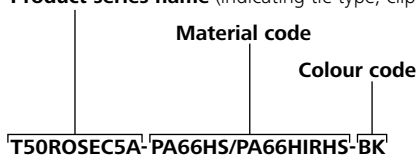

Europe

 **HellermannTyton GmbH – Austria**
Rennbahnweg 65
1220 Vienna
Tel.: +43 12 59 99 55-0
Fax: +43 12 59 99 11
Email: office@HellermannTyton.at
www.HellermannTyton.at

 **HellermannTyton – Bulgaria**
Email: officeBG@HellermannTyton.at
www.HellermannTyton.at

 **HellermannTyton – Czech Republic**
Email: officeCZ@HellermannTyton.at
www.HellermannTyton.cz

 **HellermannTyton – Denmark**
Industrivej 44A, 1.
4000 Roskilde
Tel.: +45 702 371 20
Fax: +45 702 371 21
Email: htdk@HellermannTyton.dk
www.HellermannTyton.dk

 **HellermannTyton – Finland**
Äyritie 12 B
01510 Vantaa
Tel.: +358 9 8700 450
Fax: +358 9 8700 4520
Email: myynti@HellermannTyton.fi
www.HellermannTyton.fi

 **HellermannTyton S.A.S. – France**
2 rue des Hêtres – CS 80543
78197 Trappes Cedex
Tel.: +33 1 30 13 80 00
Fax: +33 1 30 13 80 60
Email: info@HellermannTyton.fr
www.HellermannTyton.fr

 **HellermannTyton GmbH – Germany**
Großer Moorweg 45
25436 Tornesch
Tel.: +49 4122 701-0
Fax: +49 4122 701-400
Email: info@HellermannTyton.de
www.HellermannTyton.de

 **HellermannTyton KFT – Hungary**
Kisfaludy u. 13
1044 Budapest
Tel.: +36 1 369 4151
Fax: +36 1 369 4151
Email: officeHU@HellermannTyton.at
www.HellermannTyton.hu

 **HellermannTyton Ltd – Ireland**
Unit A5 Cherry Orchard
Business Park
Ballyfermot, Dublin 10
Tel.: +353 1 626 8267
Fax: +353 1 626 8022
Email: sales@HellermannTyton.ie
www.HellermannTyton.co.uk

 **HellermannTyton S.r.l. – Italy**
Via Visco, 3/5
35010 Limena (PD)
Tel.: +39 049 767 870
Fax: +39 049 767 985
Email: info@HellermannTyton.it
www.HellermannTyton.it

 **HellermannTyton B.V. – Belgium/Netherlands**
Vanadiumweg 11-C
3812 PX Amersfoort
Tel.: +31 33 460 06 90
Fax: +31 33 460 06 99
Email (NL): info@HellermannTyton.nl
Email (BE): info@HellermannTyton.be
www.HellermannTyton.nl
www.HellermannTyton.be

 **HellermannTyton AS – Norway**
PO Box 240 Alnabru
0614 Oslo
Tel.: +47 23 17 47 00
Fax: +47 22 97 09 70
Email: firmapost@HellermannTyton.no
www.HellermannTyton.no

 **HellermannTyton Sp. z o.o. – Poland**
Kotunia 111
62-400 Stupca
Tel.: +48 63 2237 111
Fax: +48 63 2237 110
Email: info@HellermannTyton.pl
www.HellermannTyton.pl

 **HellermannTyton – Romania**
Email: officeRO@HellermannTyton.at
www.HellermannTyton.at

 **OOO HellermannTyton – Russia**
40/4, Pulkovskoe road
BC Technopolis Pulkovo, office A 8081
196158, St. Petersburg
Tel.: +7 812 386 00 09
Fax: +7 812 386 00 08
Email: info@HellermannTyton.ru
www.HellermannTyton.ru

 **HellermannTyton – Slovenia**
Branch Office Ljubljana
Podružnica Ljubljana, Leskoškova 6
1000 Ljubljana
Tel.: +386 1 433 70 56
Fax: +386 1 433 63 21
Email: officeSI@HellermannTyton.at
www.HellermannTyton.si

 **HellermannTyton España s.l. – Spain / Portugal**
Avda. de la Industria 37 2º 2
28108 Alcobendas, Madrid
Tel.: +34 91 661 2835
Fax: +34 91 661 2368
Email:
HellermannTyton@HellermannTyton.es
www.HellermannTyton.es

 **HellermannTyton AB – Sweden**
Isafjordsgatan 5
16440 Kista
Tel.: +46 8 580 890 00
Fax: +46 8 580 348 02
Email: kundsupport@HellermannTyton.se
www.HellermannTyton.se

 **HellermannTyton Engineering GmbH – Turkey**
Saray Mah Dr. Adnan Büyükdenez Cad. No:4
Akkom Office Park 2. Blok Kat: 10
34768 Ümraniye-Istanbul
Tel.: +90 216 687 03 40
Fax: +90 216 250 32 32
Email: info@HellermannTyton.com.tr
www.HellermannTyton.com.tr

 **HellermannTyton Ltd – UK**
William France Road
Plymouth International Medical
and Technology Park
Plymouth, Devon PL6 5WR
Tel.: +44 1752 701 261
Fax: +44 1752 790 058
Email: info@HellermannTyton.co.uk
www.HellermannTyton.co.uk

 **HellermannTyton Ltd – UK**
Sharston Green Business Park
1 Robeson Way
Altrincham Road, Wythenshawe
Manchester M22 4TY
Tel.: +44 161 947 2200
Fax: +44 161 947 2220
Email: sales@HellermannTyton.co.uk
www.HellermannTyton.co.uk

 **HellermannTyton Ltd – UK**
Cley Road, Kingswood Lakeside
Cannock, Staffordshire
WS11 8AA
Tel.: +44 1543 728282
Fax: +44 1543 728284
Email: info@HellermannTyton.co.uk
www.HellermannTyton.co.uk

 **HellermannTyton Data Ltd – UK**
Waterside House, Edgar Mobbs Way
Northampton NN5 5JE
Tel.: +44 1604 707 420
Fax: +44 1604 705 454
Email: sales@htdata.co.uk
www.htdata.co.uk

Middle East

 **HellermannTyton – UAE**
Email: info@HellermannTyton.ae
www.HellermannTyton.ae

North America

 **HellermannTyton – Canada**
Tel.: +1 905 726 1221
Fax: +1 905 726 8538
Email: sales@HellermannTyton.ca
www.HellermannTyton.ca

 **HellermannTyton – Mexico**
Tel.: +52 333 133 9880
Fax: +52 333 133 9861
Email: info@HellermannTyton.com.mx
www.HellermannTyton.com

 **HellermannTyton – USA**
Tel.: +1 414 355 1130
Fax: +1 414 355 7341
Email: corp@htamericas.com
www.HellermannTyton.com

South America

 **HellermannTyton – Argentina**
Tel.: +54 11 4754 5400
Fax: +54 11 4752 0374
Email: ventas@HellermannTyton.com.ar
www.HellermannTyton.com.ar

 **HellermannTyton – Brazil**
Tel.: +55 11 4815 9000
Fax: +55 11 4815 9030
Email: vendas@HellermannTyton.com.br
www.HellermannTyton.com.br

Asia-Pacific

 **HellermannTyton – Australia**
Tel.: +61 2 9525 2133
Fax: +61 2 9526 2495
Email: cservice@HellermannTyton.com.au
www.HellermannTyton.com.au

 **HellermannTyton – China**
Tel.: +86 510 8528 2536
Fax: +86 510 8528 2731
Email: cservice@HellermannTyton.com.cn
www.HellermannTyton.com.cn

 **HellermannTyton – Hong Kong**
Tel.: +852 2831 9090
Fax: +852 2832 9381
Email: cservice@HellermannTyton.com.hk
www.HellermannTyton.com.hk

 **HellermannTyton – India**
Tel.: +91 120 413 3384
Email: cservice@HellermannTyton.co.in
www.HellermannTyton.co.in

 **HellermannTyton – Japan**
Tel.: +81 3 5790 3111
Fax: +81 3 5790 3112
Email: mkt@hellermannTyton.co.jp
www.HellermannTyton.co.jp

 **HellermannTyton – Republic of Korea**
Tel.: +82 32 833 8012
Fax: +82 32 833 8013
Email: cservice@HellermannTyton.co.kr
www.HellermannTyton.co.kr

 **HellermannTyton – Philippines**
Tel.: +63 2 752 6551
Fax: +63 2 752 6553
Email: cservice@HellermannTyton.com.ph
www.HellermannTyton.com.ph

 **HellermannTyton – Singapore**
Tel.: +65 6 586 1919
Fax: +65 6 752 2527
Email: cservice@HellermannTyton.sg
www.HellermannTyton.com.sg

 **HellermannTyton – Thailand**
Tel.: +662 237 6702 / 266 0624
Fax: +662 266 8664
Email: cservice@HellermannTyton.co.th
www.HellermannTyton.com.sg

Africa

 **HellermannTyton – South Africa**
Tel.: +27 11 879 6600
Fax: +27 11 879 6603
Email: jhb.sales@HellermannTyton.co.za
www.HellermannTyton.co.za